



UNIVERSITEIT•STELLENBOSCH•UNIVERSITY
jou kennisvenoot • your knowledge partner

TLHOKOMELO YA SETEROUKU

LAPENG



E bokantswe le ho hlophiswa ke ES Scheffler & SJ Visagie
Centre for Rehabilitation Studies, Stellenbosch University

Lebitso:

Mokwetlisi/moalafi:

Nomoro ya mohala:



UNIVERSITEIT•STELLENBOSCH•UNIVERSITY
jou kennisvenoot • your knowledge partner

Khopiraete © 2011 Yunivesithi ya Stellenbosch. Ditokelo tsohle di sireleditswe ka molao. Kgatiso e hlophisitsweng botjha © 2015 Yunivesithi ya Stellenbosch. Ditokelo tsohle di sireleditswe ka molao.

Kgatiso ya Khopiraete ya Sesotho © 2015 Yunivesithi ya Stellenbosch. Ditokelo tsohle di sireleditswe ka molao.

Sehlahiswa sa Centre for Rehabilitation Studies, Stellenbosch University.

E hatisiswe le ho hlahiswa Afrika Borwa.

Phatlalatso ya Elektroniki: Dipehelo tsa tshebediso

- 1 Phatlalatso ena ya elektroniki e ka hlahiswa botjha, ya hasanywa, ya bolokwa kapa ya fetiswa ka bottlalo feela, ntle le hore maqephe afe kapa afe a se kenyeletswe.
- 2 Basebedisi ba ka hlahisa botjha le ho hasanya phatlalatso ena ya elektroniki ka sebopeho sa kgatiso le elektroniki tlasa maemo a latelang:
 - i Maqephe ohle a bukana ena, a kenyeletsang maqephe a ka pele le ka morao, a tlameha ho hlahiswa botjha le ho hasanywa lekgetlo le leng le le leng.
 - ii Dikhopi tsa phatlalatso ya elektroniki ha di a lokela ho rekiswa bakeng sa phaello ya kgwebo.
 - iii Ha ho karolo ya phatlalatso ena ya elektroniki e ka fetolwang mongolo kapa sebopeho ka tsela efe kapa efe kapa mofuta ofe kapa ofe wa phatlalatso ntle le tumello e fumanweng pele ka mongolo ya monga khopiraete.

Lebisa dipotso dife kapa dife kapa mangolo ho monga khopiraete:

Head of Department
Centre for Rehabilitation Studies
Stellenbosch University
PO Box 241
Cape Town
8000

South Africa

Mohala: +27 21 938 9528
Fekse: +27 21 931 9835
Imeile: CRS@sun.ac.za

Dikateng

1. Dintho tsa bohlokwa ho di tseba mabapi le seterouku	2
2. Mathata ka kgokahano	4
3. Mathata a keello (monahano) le boitshwaro	7
4. Ka moo o lokelang ho beha motho ya otlilweng ke seterouku	8
5. Ho ja, ho kwenya le tlhokomelo ya meno/lehano	14
6. Tlhokomelo ya lehetla	20
7. Ho sisinyeha betheng	24
8. Diphetiso (ho tloha betheng ho ya setulong le ho kgutlela betheng)	29
9. Boitlhokomelo	35
10. Ho tsamaya ka thuso	50
11. Mathata a atileng kamora seterouku	51
Diteboho	52
Hobaneng re ngotse bukana ee?	53

1. Dintso tsa bohlokwa ho di tseba mabapi le seterouku

? Seterouku ke eng?

Seterouku se bakwa ke ha bo ba le mathata phallelong ya madi ho ya karolong e itseng ya boko. Mathata ana e ka ba bo bong ba a latelang:

- Tshenyeho kapa lefu le ka thibanya kapa la sesefatsa mothapo wa madi. Sena se emisa madi hore a phalle, mme se bolela hore oksijine (moya) le diahammele (dijo) di ke ke tsa fihlella dikarolo tse itseng tsa boko. Dikarolo tseo tsa boko jwale di a senyeha mme di ka emisa ho sebetsa.
- Mothapo wa madi o ka nna wa phatloha. Madi jwale a tla phallela bokong mme a bake tshenyo.

? Na batho ba ka hlaphohelwa kamora seterouku?

Seterouku ka seng se fapane. Ho ipapisitse le hore na ke karolo efe ya boko e senyehileng.

- Ka tlwaelo, batho ba pholohang seteroukung ba hlaphohelwa butlebutle kamora nako e telele, empa hangata ba ke ke ba hlola ba kgutlela boemong ba bona ba qalong ka botlalo.
- Bongata ba batho ba ithuta ho tsamaya hape, empa ba tsamaya butle mme ba ka wa ha bonolo.
- Batho ba bangata ha ba boellwe ke motsamao wa bona kapa taolo ya letsoho kapa sephaka sa bona kaofela.
- Mesifa e meng e ka dula e holofetse mme e fokola, mme e meng e ka satalla. Sena se etsa hore ho be thata ho diphofu tsohle tsa seterouku ho tsamaya le ho laola mmele ya bona.
- Bokgoni ba mmele ba batho ba bang (metsamao le taolo ya mmele) bo batla bo boela madulong hape ka botlalo.
- Batho ba bang ba tswela pele ho ba le mathata ka di tshebetso tsa bona tsa keello (jwalo ka ho nahana, ho etsa diqeto le ho tseba ho qoba kotsi).

? Na moriana o ka ntlafatsa seterouku?

Ha ho kgonehe hore disele tse shweleng tsa boko di phele hape. Empa haeba o alafa mathata a bophelo a bakang seterouku, o ka thusa ho thibela diseterouku tse ding hape. Mathata a bakang diseterouku ke lefu la tswekere (tswekere e phahameng mading), kगतello e phahameng ya madi, kholesterole e phahameng (mafura a mangata mading) le mathata a pelo. Motho ya otlilweng ke seterouku o tlameha ho bona ngaka hore a alafelwe mafu ana le ho hlaloba hore na ha ho mathata a mang.

? Ke mathata afe ao batho ba atisang ho ba le oona kamora ho otlwa ke seterouku?

Batho ba ka ba le mathata a latelang kamora ho otlwa ke seterouku:

- Phokolo kapa kgolofalo ya lehlakore le le leng la mmele
- Ho satalla ha sephaka, letsoho le/kapa tlhafu
- Ho sokola ho ba le botsitso, ho wela ha bonolo ha a dutse kapa ba a eme
- Ho sokola ho bua kapa ho utlwisisa puo
- Ho sokola ho laola senya sa bona le mala (ho hloka ho ya ntlwaneng) (empa sena ka tlwaelo se a ntlafala ha nako e ntse e tsamaya)
- Tahlehelo ya kutlo lehlakoreng le fokolang la mmele ya bona
- Ho bonahala ha ho lebala ka/ho iphapanyetsa lehlakore le fokolang la mmele ya bona
- Mathata a pono (ho bona)
- Ho bonahala motho a ferekane le ho sokola ho hopola
- Diphetoho tsa maikutlo le botho
- Ho lebala ka moo o lokelang ho etsa di tshebetso tsa letsatsi le letsatsi



Nka alafa motho ya otlilweng ke seterouku jwang?

- Dumella motho eo ho qeta nako e nyane ka moo ho ka kgonehang a le dikobong. Ho qeta nako e telele haholo dikobong ho baka phokolo e eketsehileng. Ho seng jwalo mo nkise dikgefu tse kgutshwane tsa phomolo.
- Dumella motho eo ho tsoha ka dinako tsa hae tsa tlwaelo hore a hlape le ho apara.
- Dumella motho eo ho fumana dijo mmoho le ditho tse ding tsohle tsa lelapa jwalo ka ka tlwaelo.
- Leka ho thusa motho eo ho latela lenaneo le hlophisitsweng la letsatsi le letsatsi.
- Kgothaletsa motho eo ho iketsetsa dintho ka boyena. Eba le mamello mme o mo fe nako e eketsehileng hore a phethe le ho ikwetlisetsa ditshebetso. Ho iketsetsa dintho tse ngata ka hohle ka moo a ka kgonang le dintho tsa letsatsi le letsatsi ke boikwetliso bo mo loketseng.
- Hopola hore motho eo ke motho e moholo; le ka mohla o se tshware batho ba otlilweng ke seterouku jwalo ka ha eka ke bana.

2. Mathata ka kgokahano

? Kgokahano ke eng?

Kgokahano ke ka moo re arolelanang tlhahisoleseding le batho ba bang ka ho buisana, ho bontsha ka matsoho, ho ngola kapa ka ditsela tse ding, le bokgoni ba rona ba ho utlwisisa tlhahisoleseding eo.

? Ke mathata afe a kgokahano ao batho ba otlilweng ke seterouku ba atisang ho ba le oona?

Diphofu tsa seterouku di ka ba le mathata a latelang a kgokahano:

- Botholo kapa ho se utlwe hantle. Sena e ka ba karolo ya ho tsofala mme ha se kamehla se bakwang ke seterouku. Mooki wa tleliniking a ka etsa bonnete ba hore ha ho letho le thibileng karolo e kantle ya tsebe (karolo eo re ka kgonang ho e sheba), jwalo ka dikonokono.
- Ho sokola ho utlwisisa
- Ho se kgone ho rera puo (ho kopanya medumo e nepahetseng mmoho ho bopa mantswa)
- Ho se kgone ho nahana ka mantswa a nepahetseng
- Ho se kgone ho laola mesifa e ka re thusang ho bopa mantswa, jwalo ka leleme le mesifa ya mohlahare
- Ho se kgone ho bala, ho ngola kapa ho utlwisisa ditshwantsho
- Ho se kgone ho buela hodimo

? Nka sebetsana le mathata aa a kgokahano jwang?

Ha o bua le phofu ya seterouku:

- Bua o shebisitse sefahleho sa hao mothong eo.
- Sheba motho eo ka mahlong.
- Eba haufi le motho eo.
- Bua butle le ka ho hlaka, haholo haeba motho eo a kgathetse.
- Sebedisa lentwe la hao le tlwaelehileng. Se ke wa hoeletsa.
- Pheta seo o se buileng haeba motho eo a sa utlwisisa.
- Sebedisa dipolelo tse kgutshwane.
- Ema nakwana dipakeng tsa dipolelo.
- Sebedisa matsoho ha o bua (bontsha ka matsoho a hao).
- Bua dintho tse tlwaelehileng, ditaba tsa kamehla.
- Haeba motho eo a sa kgone ho bua, botsa dipotso tse ka arajwang ka karabo e bonolo ya 'ee' kapa 'tjhe'.
- Haeba o se na bonnete ba hore na motho eo o utlwisitse, mo kope hore a phete ntlha ya bohlokwa ya taba eo.

Ha o mametse phofu ya seterouku:

- Eba le mamello.
- Sheba molomo wa motho eo.
- Hopotsa motho eo ho bua butle le ka ho hlaka.
- Hopotsa motho eo ho tsepamisa maikutlo haholwanyane ha a sebedisa mantswe a thata.
- Kopa motho eo ho pheta ntho haeba o sa e utlwisise. Se ke wa etsa eka o a utlwisisa.
- Kgothaletsa motho eo ho sebedisa mabitso a metswalle le ditho tsa lelapa.
- Kgothaletsa motho eo ho sebedisa mantswe a tlwaelehileng jwalo ka 'dumela' kapa 'ke a leboha'.
- Haeba motho eo a sa kgone ho bua, mo kgothaletse ho sebedisa matsoho le ho supa dintho.

Ka kakaretso:

- Etsa bonnete ba hore ha ho lerata le hlahang ka morao.
- Theola modumo wa thelevishene kapa radiyo.



Ke eng se seng seo nka se etsang ho thusa ka kgokahano?

A	B	C	D	E	F	G
H	I	J	K	L	M	N
O	P	R	S	T	U	V
W	Q	1	2	3	4	5
6	7	8	9	10	Yes	No

Sebedisa boto ya alefabate. Diphofu tse ding tsa seterouku di ka nna tsa kgona ho peleta seo ba se batlang.

Aksiewoorde

sit	leap	leap	sleep
vibrant	sun	stop	walk
sick	laugh	poor	marry
delicious	drink	eat	

ALGEMEEN

phone radio book television

MENSE

woman doctor family man group

WOORDE **SINNE**

Hallo Ek is dors.
 mōre Ek is honger.
 Totsiens Ek wil toilet toe.
 sit Hoe laat is dit?
 loop Hoe gaan dit?
 bit gaan goed.
 Baie dankie!

Sebedisa tjhate (phoustara) e nang le ditshwantsho le/ kapa mantswe.

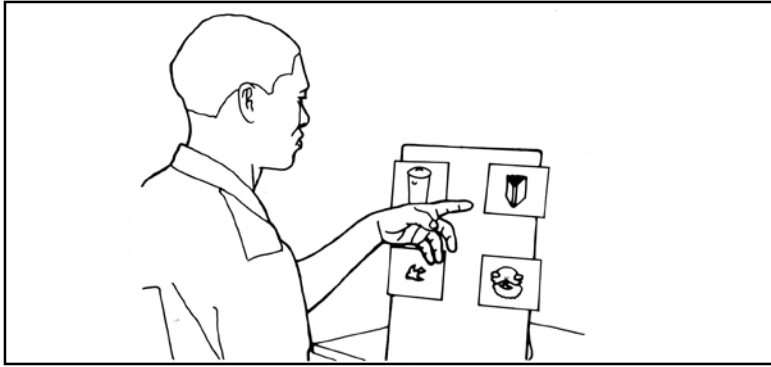

Sebedisa ditshwantsho.



Sebedisa matshwao a matsoho.

3. Mathata a kelello (monahano) le boitshwaro

? Ke mathata afe a ka hlahang mabapi le monahano wa phofu ya seterouku le boitshwaro ba hae?

Ka lebaka la tshenyeho e bokong ba bona, diphofu tse ding tsa seterouku di ka sokola ho hopola kapa ho utlwisisa dintho. Ba bang ba fumana ho le thata ho laola maikutlo le ditakatso (ditlhoko) tsa bona, mme ba itshwara ka ditsela tse sa tlwaelehang. Empa ha se diphofu tsohle tsa seterouku tse nang le mathata ana. Moalafi wa tsa tshebetso a ka hlahloba hore na motho eo o na le dintho tse na.

? Matshwao a mathata aa ke afe?

O ka nna wa lemoha dintho tse latelang:

- Pherekano: Motho eo ha a kgone ho lemoha batho, ho tseba moo a leng teng (sebaka) kapa hore nako ke mang kapa ke labokae.
- Mathata a kgopolo ya nako e kgutshwane: Ho etsa mohlala, motho eo ha a kgone ho hopola se builweng nakong ya hora feela e fertileng.
- Ha a etse letho ntle le ho jwetswa: Ho etsa mohlala, motho eo o dula a robetse ntle le ho jwetswa hore a tsohe.
- O sokola ho etsa mesebetsi e bonolo: Mesebetsi e jwalo ka ho apara jeresi e ba thata haholo.
- Ha a be le taolo (ho etsa mohlala, ya kgalefo, ya takatso ya thobalano kapa ho ja): Motho eo a ka etsa dintho pele a ka di nahanisisa.
- Boitshwaro bo sa lokelehang: Ho etsa mohlala, motho eo a ka tsheha motho ya lemetseng.
- A ka batla dintho tse ngata (a tena): Ho etsa mohlala, phofu ya seterouku e ka nna ya batla hore e tsotellwe hanghang kapa ka nako yohle.
- Ho se natse lehlakore le fokolang la mmele: Ho etsa mohlala, ha a ntse a batla ntho e it-seng, motho eo a ka nna a se ke a leka le ho sheba lehlakore la hae la mmele le fokolang.
- Ha a utlwisise tjehelete kapa ka moo a ka e sebedisang.
- Ho tetebeba maikutlo/ho ikutlwa a hloname hahlohadi mme a 'wele moya' nako yohle.
- Ho kopa tshwarelo nako e telele bakeng sa boitshwaro bo makatsang, hobane motho eo ha a lemohe mathata ana.

? Nka sebetsana le mathata aa jwang?

- Fumana thuso ya seprofeshenale ho tswa ho moalafi wa tsa tshebetso kapa moalafi wa tsa kelello wa boitshwaro (kopa tleliniking ya heno e haufi hore ba o fetisetse ho motho ya nepahetseng).
- Jwetsa phofu ya seterouku mohla, letsatsi le nako hangata. Beha tshupanako le khalenda ka phapusing mme o di bontshe motho eo nako le nako.
- Latela tlwaelo e tshwanang letsatsi le letsatsi, ka dijo, boitlhokomelo (ho hlapa, ho hlapa meno, ho kama moriri) le ho phomola ka nako e tshwanang le ka tsela e tshwanang, letsatsi le leng le le leng.
- Qala ho hlalosa diphetoho diketsong tsa tlwaelo e sa le pele ho nako eo di tla etsahala ka yona, ho etsa mohlala ha o hloka ho ya lebenkeleng kapa tleliniking. Pheta tlhaloso hangata.
- Se ke wa dumella boitshwaro bo itseng ka letsatsi le leng ebe o a bo hanela matsatsing a mang. Etsa qeto mabapi le seo o bonang e le boitshwaro bo amohelehang, mme o kgeme le bona.
- Se ke wa dumella motho eo ho o laola ka boitshwaro bo bobo. Ho etsa mohlala, se ke wa qetella o dumetse seo a se batlang hobane feela a flatsitse lerata.
- Eba le melawana e hlakileng bakeng sa boitshwaro bo sa amohelehang. Ho etsa mohlala, ere: 'Se ke wa hoeletsa. Nkeke ka o araba ha o hoeletsa.'
- Se ke wa tsheha boitshwaro bo makatsang kapa bo bobo, jwalo ka ho rohakana, leha ho ka qabola.
- Jwetsa motho eo ha boitshwaro ba hae bo le botle mme bo amoheleha. Ho etsa mohlala, ere: 'Ke thabela ho o thusa ha o bontsha teboho.'
- Dumella motho eo ho thusa ho etsa diqeto.
- Dumella motho eo ho etsa dintho tse ngata ka moo a ka kgonang, empa o dule o le haufi ho lekana ho etsa bonnete ba hore o bolokehile, ho etsa mohlala ha a le ka phapusing ya ho hlapela le ka kitjhining.
- Ke ntho e tlwaelehileng bakeng sa diphofu tsa seterouku hore ba lle ha bonolo. Haeba ho lla ho bakwa ke tetebebo ya maikutlo, kgelosa menahano ya hae ka ho mo kopa ho bala ho fihla ho leshome kapa a hemele kahare ka matla. Se ke wa bontsha qenehelo e kgolo haholo hobane sena se tla etsa hore a lle ho feta.

4. Ka moo o lokelang ho dudisa motho ya otlilweng ke seterouku

Ha diphofu tsa seterouku di robala kapa ho dula ka tsela e nepahetseng, sena se ka ba thusa ho hlaphohelwa kapele le ho sebetsa ka tsela e ntlafetseng. Ho dula kapa ho robala ka tsela e sa nepahalang ho ka mpefatsa mathata a jwalo ka ho satalla ha ditho, bohloko kapa ha kenakenana le hore a se lemohe lehlakore le fokolang.

? Motho eo o lokela ho robala jwang betheng?

Melawana e akaretsang:

- Sebedisa materase a tiileng (a se be bonolo haholo, mme a se be thata haholo), kapa kenya boto ya patsi jwalo ka lemati la kgale tlasa materase.
- Lebota le tlameha hore kamehla le tobane le lehlakore le matla la motho eo.
- Motho eo o tlameha hore a robale ka tsela eo lehlakore le fokolang le shebileng lemat-ing, thelevisheneng, setulong sa baeti, jwalo jwalo. Sena se tla mo thusa hore a se lebale kapa a tsotelle lehlakore la hae le fokolang.
- Motho enwa o tlameha ho geta nako e nyane ka moo ho ka kgonehang a le dikobong.
- Ha a le dikobong, motho enwa o tlameha ho robala ka lehlakore ho fapana le ho kakalla.
- Fetola motho ya sa kgoneng ho sisinyeha ho hang dihora tse ding le tse ding tse pedi ho isa ho tse tharo ho thibela ho kgathala lehlakore le diso tse bakwang ke ho robala.

Ka moo a lokelang ho robala ka mahlakore a mabedi

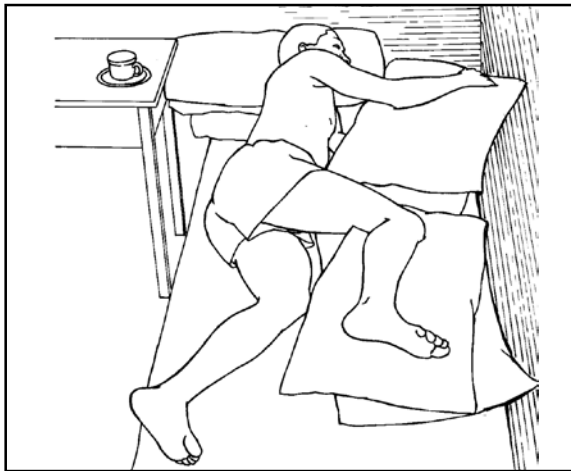

Ho robala ka lehlakore le matla

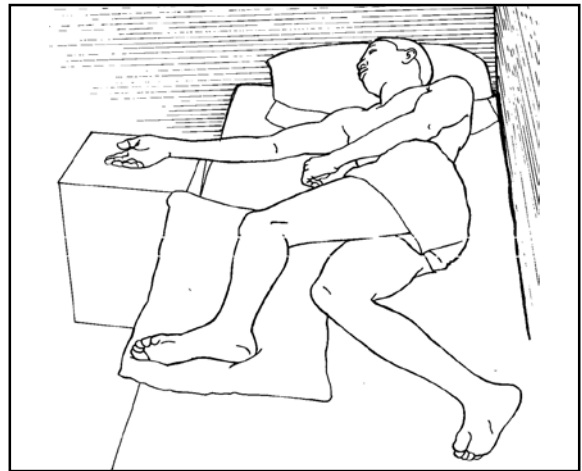

Ho robala ka lehlakore le fokolang.

1. Boloka setswe thoko le mmele le ka tsela e sa kukuneleng.
2. Boloka letsoho le fokolang le bulehile, le sa fupara letho.
3. Ha a robetse ka lehlakore le matla, kenya ntho e nngwe tlasa setswe se fokolang le letsoho ho mo tshehetsa.
4. Ha a paqame ka lehlakore le fokolang, se ke wa dumella motho eo ho robala a hateletse lenonyeletso la lehetla. Beha lehetla ka pele ho sefuba mme e seng ka tlasa mmele.
5. Koba lengwele le hodimo.
6. Kenya mesamo kapa kobo e mennweng tlasa lengwele le hodimo le leoto hore le tshehetswe ka botlalo.
7. Haeba bethe e se sephara ho lekana, beha letsoho le fokolang le sephaka hodima lebokose la khateboto kapa tafole e pela bethe. Hlahloba hore lebokose kapa tafole e phahame ho lekana hantle le bethe - e se be tlase kapa hodimo.

Ka moo a lokelang ho kakalla

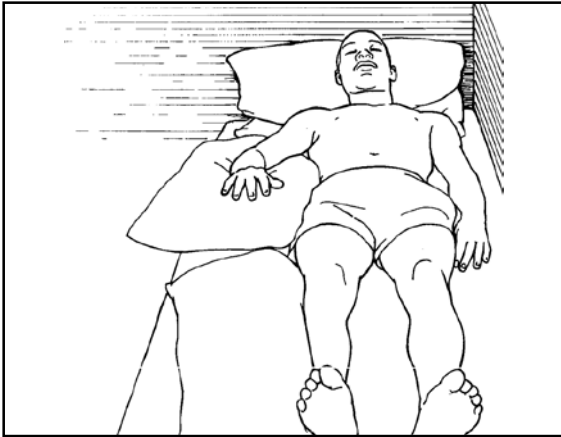

1. Motho eo a ka kakalla nakwana e kgutshwane feela.
2. Beha tafolana ya bethe lehlakoreng le fokolang.

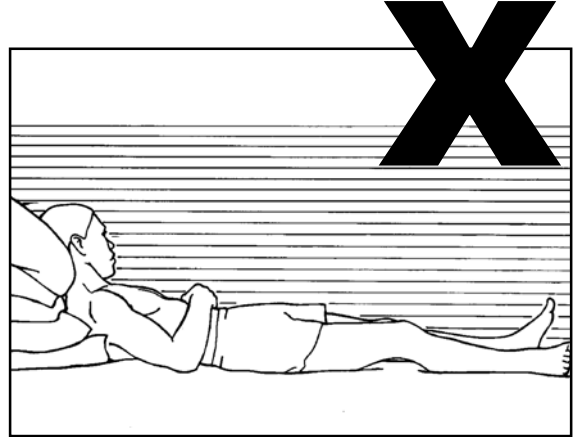

Se ke wa robatsa motho eo betheng e kentsweng mesamo ka flasa mokokotlo wa hae. Sena se ka baka:

- Diso tsa ho robala
- Mathata a ho phefumoloha
- Mathata a ho kwenya
- Ho satalla ha sephaka le leoto
- Lesapo la mokokotlo le kobehileng le hlooho e kobehetseng pele

Ka moo a lokelang ho dula ka teng betheng (ha feela motho eo a sa kgone ho theoha betheng)

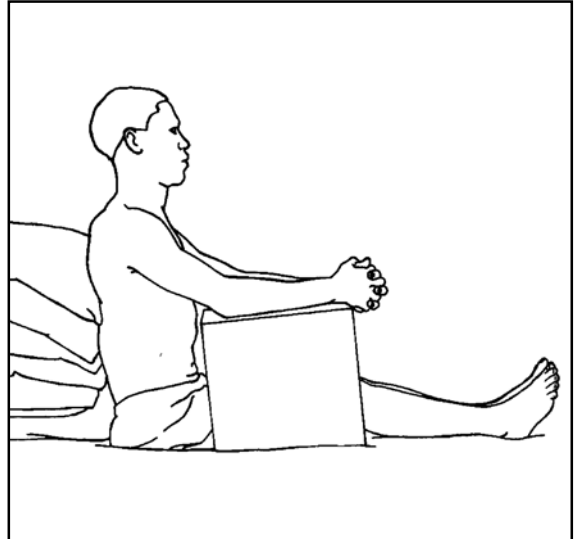
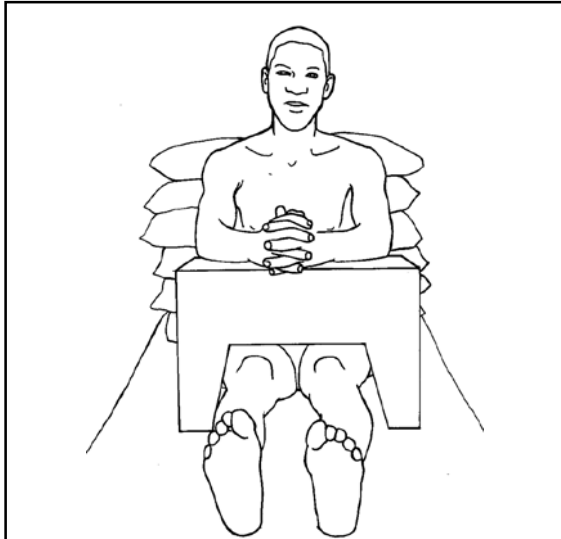

1. Dumella motho eo ho dula a tsepame mme maoto a hae a mabedi a otloletswe pele. Ha o ka kenya mosamo flasa mangwele sena se ka nna sa etsa hore a dule ka boiketlo.
2. Mokokotlo o flameha ho itshetleha leboteng kapa hetebotong. Haeba motho eo a sa kgone ho atamela karolo e hodimo ya bethe, kenya setulo kapa setulwana dipakeng tsa hae le le heteboto.
3. Kenya mesamo kapa kobo e mennweng ka mahetleng ho tshehetsa mokokotlo.
4. Etsa tafolana e dulang diropeng ka lebokose (sheba ka flase mona), moo diphaka di ka phomolang teng.
5. Motho enwa o flameha ho dula ka tsela ena feela haeba a sa kgone ho theoha betheng.

Ka moo o lokelang ho etsa tafolana e dulang diropeng ka lebokose la khateboto

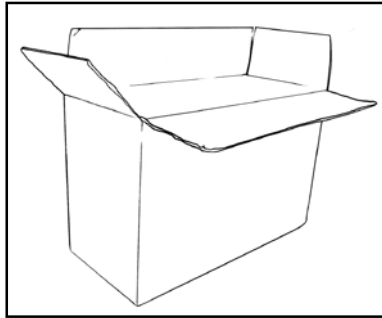

1. Sebedisa lebokose le matla le sephara ho lekana hore diphaka ho pedi di ka dula hantle hodima lona.

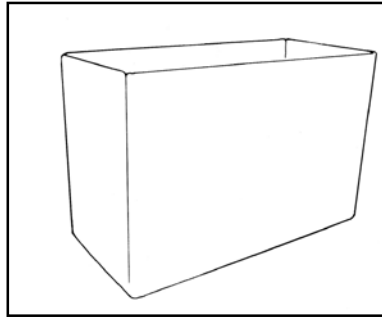

2. Seha mapheo kapa o a kgomaretse ka sekgomaretsi bokahareng ba lebokose ho matlafatsa mahlakore.

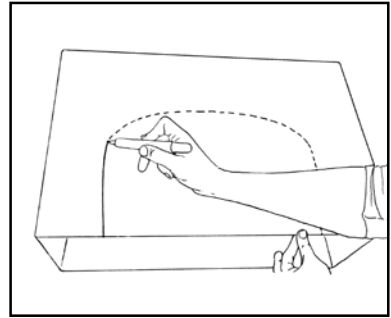

3. Taka dikgetjhana tse kgidikwe mahlakoreng a mabedi a lebokose. Sena ke ho etsa lesoba bakeng sa maoto hore a kene ka tlasa tafole, ka hona etsa bonnete ba hore a maholo ho lekana.

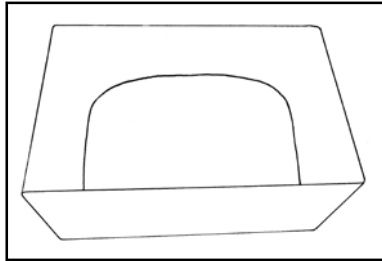

4. Sena ke ka moo masobana a lokelang ho shebeha ka teng ha o qetile.

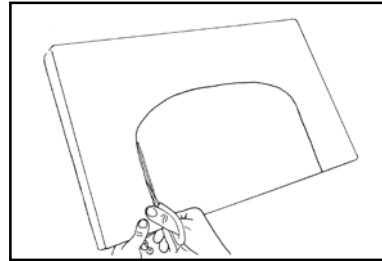

5. Jwale seha lesobana moleng oo o takileng.

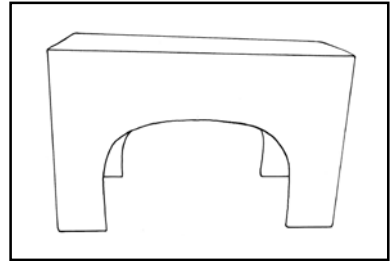

6. Tafolana ya hao e dulang diropeng jwale e lokile ho ka sebediswa.



Motho o lokela ho dula jwang?

Ka moo o lokelang ho dula setulong kapa hwiletjhereng

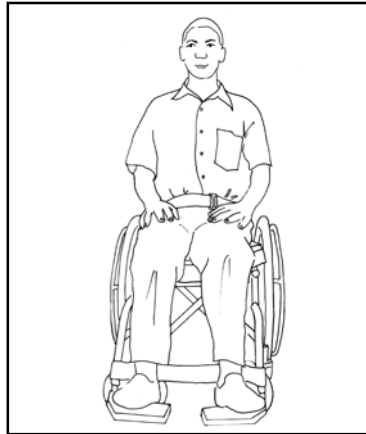

**Kamehla sebedisa
khushene ya
hwiletjhere
hwiletjhereng.**

Melawana e akaretsang:

- Setulo se tlameha ho koropela ka tsela e lekaneng hore motho a kgone ho kgohlela a feletse kahara setulo.
- Setulo se tlameha ho tiya. Sebedisa setulo se nang le boitshetleho bo thata le bodulo bo tiileng ho fapana le setulo se bonolo (se mabothobotho).
- Motho eo o tlameha ho dula a tsepame ka hohle ka moo ho ka kgonehang, moko-kotlo wa hae o otlolohile boitshetlehang ba setulo.
- Dirao tsa motho eo di tlameha ho dula di thetsitse bokamorao ba setulo. Haeba a ikutlwa a sa tsitsa kapa a kukunelwa ha dirao tsa hae di ile morao haholo, kenya mosamo o monyane ka mora hae setulong.
- Beha maoto a motho eo fatshe kapa mehatelong bakeng sa tshehetso. Haeba maoto a sa thetse fatshe, a tshehetse ka lepolanka, setha sa dikoranta kapa khateboto e tlangweng.

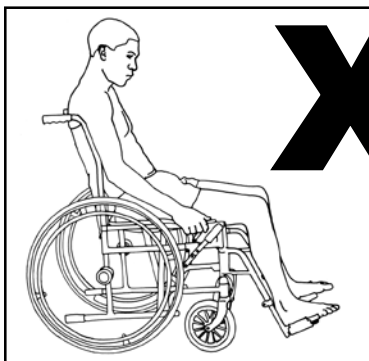

Ha diphofu tsa seterouku di sa dule ka tsela e nepahet-seng, sena se ka baka:

- Makukuno kapa bohloko
- Ho satalla ha leoto kapa sephaka se fokolang
- Ho ruruha ha letsoho le sephaka
- Ho thella setulong



Mabanta a ka thibela jwang hore a se wele ha a dutse setulong?

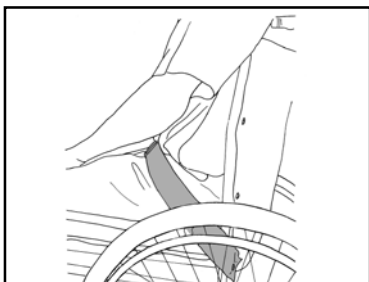

Tlamella motho eo ka tsela eo mabanta a parotseng diqholo, ka mabanta a tswang dihukung tse tlase tsa setulo.

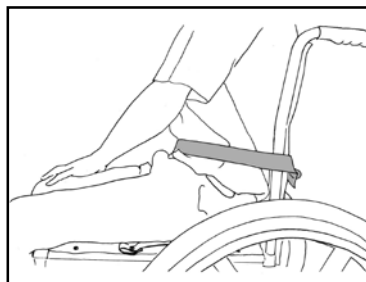

Se ke wa mo tlama mpeng kapa sefubeng.

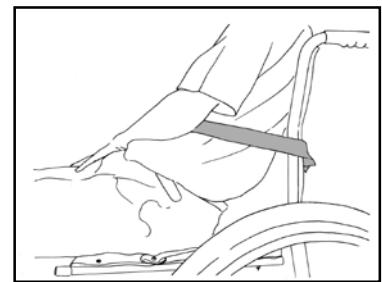

Motho eo o ntse a tla ritsa haeba o sebedisa lebanta mpeng kapa sefubeng.



Lebanta la diropeng le tlameha ho tlamellwa jwang setulong?

Bakeng sa hwiletjhere

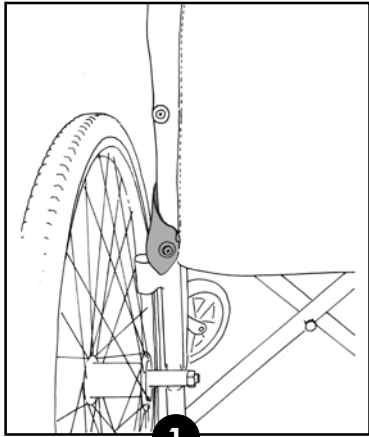

Tlrama lebanta foreimeng ya hwiletjhere ka ho sebedisa sekerufo se tlase sa boitshetleho ba hwiletjhere kapa sekerufo se kamorao sa setulo.

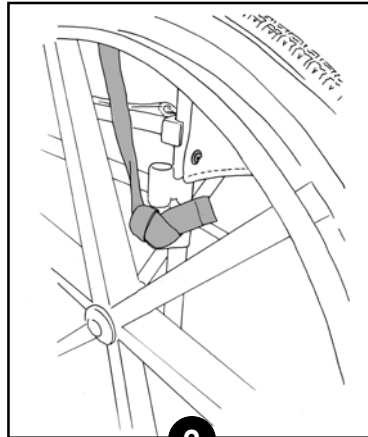

Hape o ka tlamella lebanta karolong e emeng e tsepame ya foreime ya wiletjhere, ka tlasana feela ho qetello ya bokamorao ba setulo.

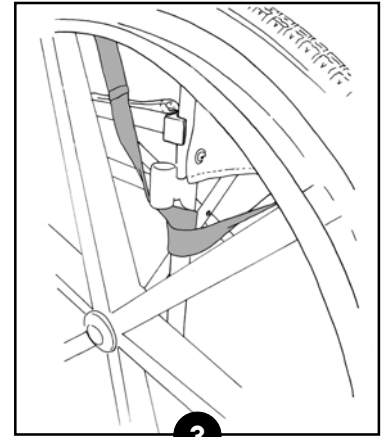

Haeba o sebedisa lebanta le letelele le tlamellwang ka pele ho motho, le hakise le ho le potolohisa karolong e emeng e tsepame ya foreime ya wiletjhere lehlakoreng le le leng, ka tlasa qetello e kamorao ya setulo.

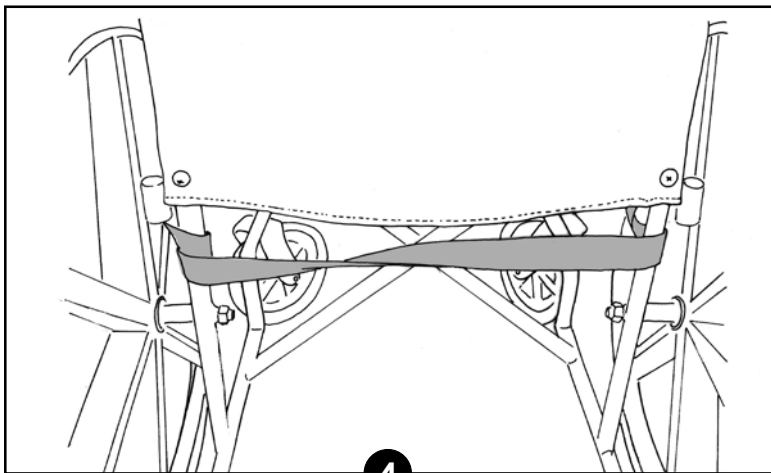

Ebe o tsamaisa lebanta ka morao ho ya lehlakoreng le leng la foreime le tlasa qetello e tlase ya setulo.

Bakeng sa setulo se tlwaelehileng

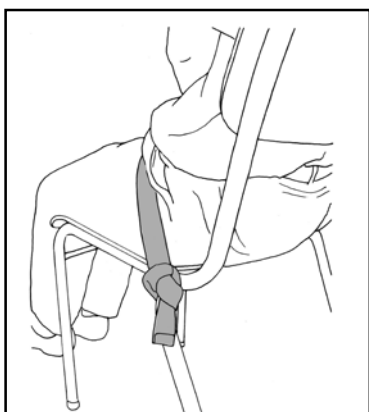

Tlrama lebanta maotong a ka morao a setulo, ka tlasana ho bodulo.



Nka tshehetsa diphaka le matsoho jwang?



Tafoleng.

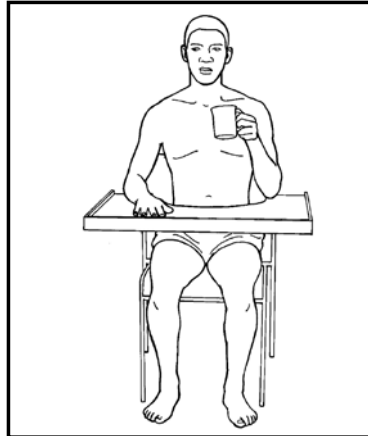

Tereing e dulang hodima maoto.



Se ke wa
kenya sephaka
kahara hakisi
ya molaleng.

Melawana e akaretsang:

- Kamehla etsa bonnete ba hore sephaka se ka tlase kaofela, ho kenyeletswa setswe le letsoho, di dula tafoleng, sebakeng sa boitshwareletso kapa tafoleng ya terei. Sheba mohlala wa terei e ka tlase mona.
- Letsoho le tlameha ho buleha mme le behwe ka tsela eo seatla se shebileng tlase, se bataletse tafoleng, boitshwareletsong kapa tereing.
- Se ke wa sebedisa mesamo hodima dirope ho tshehetsa sephaka se fokolang ha motho eo a dutse. Sena ha se fane ka tshehetso e lekaneng, mme letsoho le ka ruruha kapa lenonyeletso la lehetla le ka saroloha le ho buleleha. (Tlhokomelo ya lehetla e hlalositse Kgaolong ya 6.)

Mohlala wa tafole ya terei

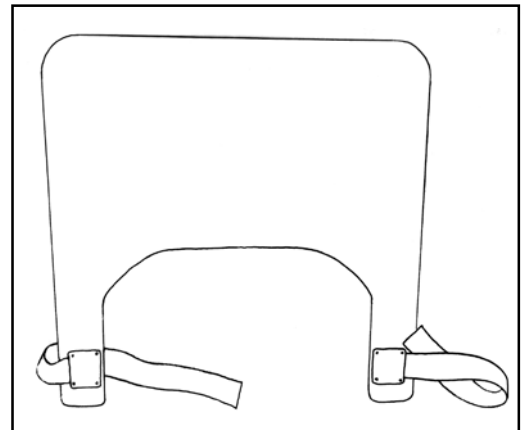
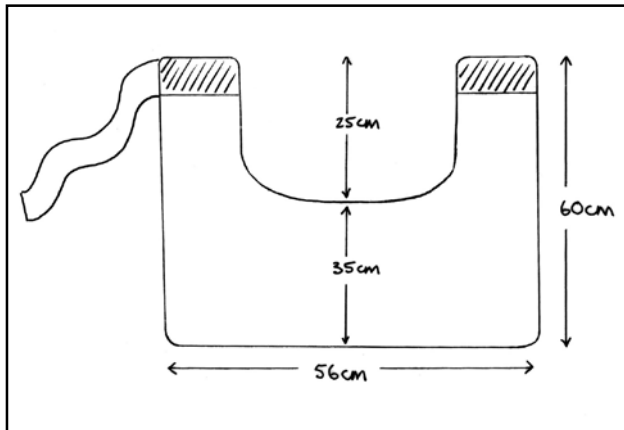

O ka etsa tafole ya terei ka boto e thata kapa plywood e tshesane. Hohla bokahodimo le methati tsa tafole ya terei ka pampiri e mahwashe (sand paper). Bokahodimo bo ka pentwa kapa ba tlotswa ka vanishe ho sireletsa hore metsi a se e senye le ho dumella hore e hlwekiswe ha bonolo. Saese e ka lekangwa ho latela ditekanyo tsa setulo le motho ya se dulang.

5. Ho ja, ho kwenya le tlhokomelo ya meno/lehano



Nka thusa motho eo ho ja jwang?

Motho eo o flameha ho etsa dintho tse latelang:

- A dule a tsepame bakeng sa dijo tsohle.
- A dule a tsepame.
- A ise hlooho ya hae pele hanyane.
- A shebe dijo.
- A behe matsoho tafoleng.
- a behe maoto a tsitsitse mehatelong ya hwiletjhere kapa fatshe.
- A hlafune ka methamo e menyane le ho nwa hanyane ka nako.
- A ise dijo tse hlafunwang bohareng ba leleme pele a ka kwenya.
- A nwe ho tswa galaseng e tletseng kapa a sebedise lehlakana ho thibela hore hlooho e qethohe.
- A dule a tsepame nako ya metsotso e bonyane 20–30 kamora ho ja hore dijo di silehe.



Haeba motho eo a kgohele hangata kapa a kangwa ke dijo ha a eja, kopa ho bona moalafi wa puo. Yena a ka hlahloba hore na motho eo a ka kwenya dijo le dino ka polokeho, mme a fane ka dikeletso tsa ho ntlafatsa ho kwenya.

Mohlokomedi o flameha ho etsa dintho tse latelang:

1. A dule ka pele ho motho eo, kapa a eme pela motho eo.
2. Ha a ema, a behe leoto le leng setshehetsong se tlase, jwalo ka boloko ba lepolanka kapa bentjhe e tlase.
3. Kamehla dula o tsepamisitse mokokotlo wa hao; o se o kobe.
4. Sebedisa sephaka sa hao haufi ka ho fetisisa le motho eo ho tshehetsa hlooho ya hae.
5. Kenya dijo dipakeng tsa meno, ka lehlakoreng le matla la lehano la motho eo.
6. Mo fepe mekedikedi e tiileng le dijo tse nang le kutlwahalo e boreledi. Yokate, khastate le sopho e tiileng ho bonolo ka ho fetisisa ho ka di kwenya.



- Se ke wa dumella hlooho ya motho eo ho kobehela pele kapa ho qethoha.
- Se ke wa dumella sephaka se fokolang hore se leketle kapa se tlohe tafoleng, boitshwareletsong kapa tereing e diropeng.
- Se ke wa tlohela maoto hore a leketle mehatelong ya hwiletjhere.



- Motho eo ha a lokela ho nanabetsa hlooho ya hae le molala hodimo kapa pele hore a fihlelle dijo. Sena se etsa hore ho be thata ho kwenya.
- Tshwarella kgaba ka kotloloho ka pele ho molomo.
- Isa kgaba molomong wa motho eo. Motho eo ha a lokela ho tsamaisa hlooho ya hae hore a fihlelle dijo.

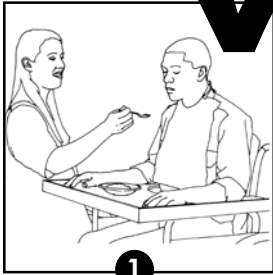

1

Tshwarella kgaba ka pele ho leleme.



2

Haeba leleme le tswa pele, le sutule-tse tlase ha bobebe ka kgaba.



3

Etsa bonnete ba hore dipounama di moma kgaba kaofela.



4

Kenya dijo dipakeng tsa meno, ka lehla-koreng le matla la lehano.



Nka thusa motho eo ho nwa jwang?



- Beha menwana ya hao lerameng la motho eo, seledung le mohlareng ho mo thusa ho kwala dipounama kapa lehano. Hlokomela hore o se sekamisetse hlooho morao.



- Ha o sebedisa lehlakana, kamehla le kenye lehlakoreng le matla la lehano kgahlanong le lerama.



- Haeba motho a sa kgone ho nwa ho tswa koping kapa ho sebedisa lehlakana, sebedisa sirinje (e hlabang ente) e sa kenngwang nalete ho kenya mokedikedi ka hanong.
- E kenye lehlakoreng le matla la lehano, kgahlanong le lerama. Tsaraletsa mokedikedi kahare lerameng.



Nka thusa motho ya sokolang ho hlaba dijo ka fereko/ kgaba ka letsoho le le leng jwang?

Sebedisa poleiti e sekoti kapa poleiti e nang le bothibeletso (e thibeletsang) hore dijo di se qhalane poleiting

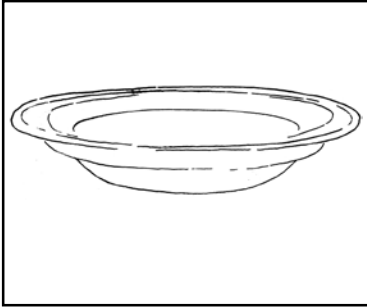

Poleiti e sekoti.



Poleiti e nang le bothibeletso e rekilweng lebenkeleng.

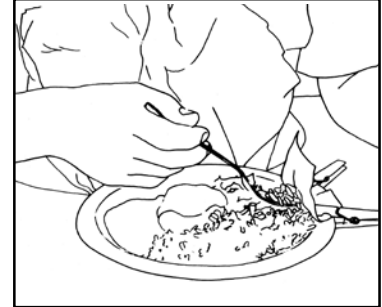

Sethibeletso sa poleiti se iketseditsweng lapeng.

Ka moo o ka iketsetsang sethibeletso sa poleiti

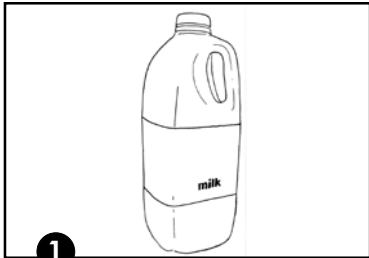

1 Nka botlolo e le nngwe kapa tse pedi tsa lebesa kapa juse tse lephaka tsa dilitara tse pedi.

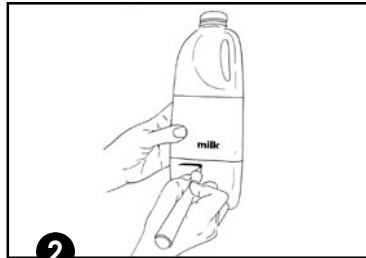

2 Taka mola wa botelele ba 5 cm ho tloha tlase botlolong (o tsamayang tlase botlolong).

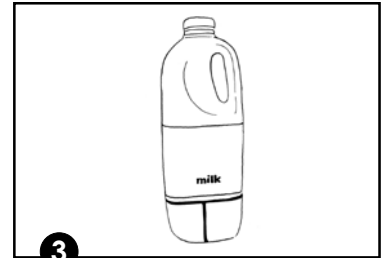

3 Taka mola o tsamayang moleng o rapameng, o parola karolo e tlase ya botlolo.



4 Seha moleng o rapameng ho ntsha setono sa botlolo.



5 Ntsha karolo e tlase.

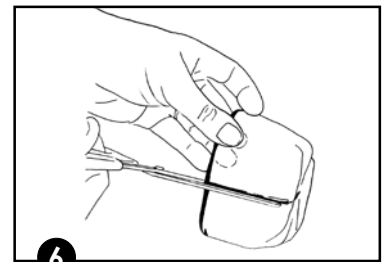

6 Ntsha karolo e tlase mme o etse dikotwana tse pedi moleng o parolang ka lehare.

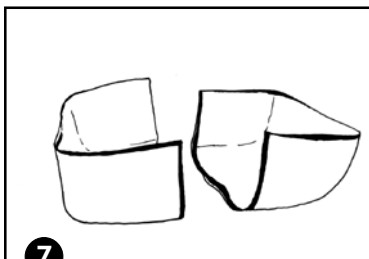

7 Jwale o na le dikotwana tse pedi tse arohaneng tsa karolo e tlase ya botlolo..

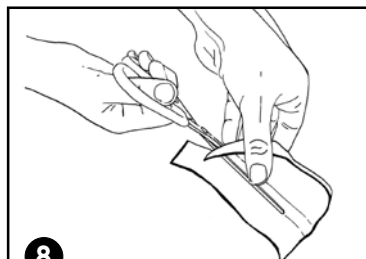

8 Sebedisa se seng sa dikotwana tsena. Seha lehlakore le le leng hore le be bophara ba poleiti.

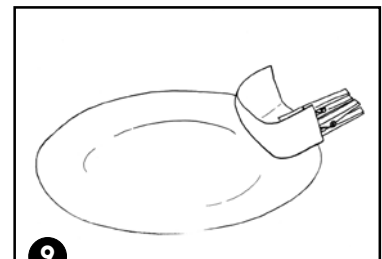

9 Se hokele mothating wa poleidi ka diphekse tsa dipahlo.

Ka moo o lokelang ho etsa boto ya ho tlotsa le ho kgabela bakeng sa batho ba sebedisang letsoho le le leng feela



Ho tlotsa ka letsoho le le leng.



Ho kgabela ka letsoho le le leng.

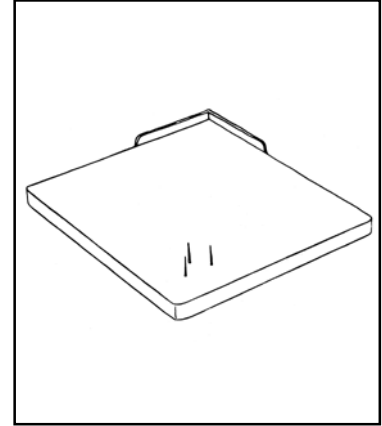

Motswako wa boto ya ho tlotsa le ho kgabela bakeng sa batho ba sebedisang letsoho le le leng feela

O hloka:

- Sekotwana sa lepolanka, jwalo ka boto ya kgale ya ho kgabela borotho, ya 15 cm x 15 cm
- Dipekere tse tharo tsa botelele ba 8 cm
- Dipekere tse nne tse kgutshwane
- Dikotwana tse pedi tsa metale kapa polasetiki e thata, tsa botelele ba 6 cm le bophahamo ba 1 cm ho feta lepolanka

Mokgwa:

1. Hamore le dipekere tse tharo tse telele hukung e le nngwe ya lepolanka ho etsa kgutlotharo kapa sekwere (sheba setshwantsho).
2. Sebedisa dipekere tse kgutshwane ho hokela dikotwana tsa metale kapa tsa polasetiki mahlakoreng a mabedi a huku a tobaneng le dipekere. Dikotwana di flameha ho hlahella ka botelele ba 1 cm ka hodimo ho boto.

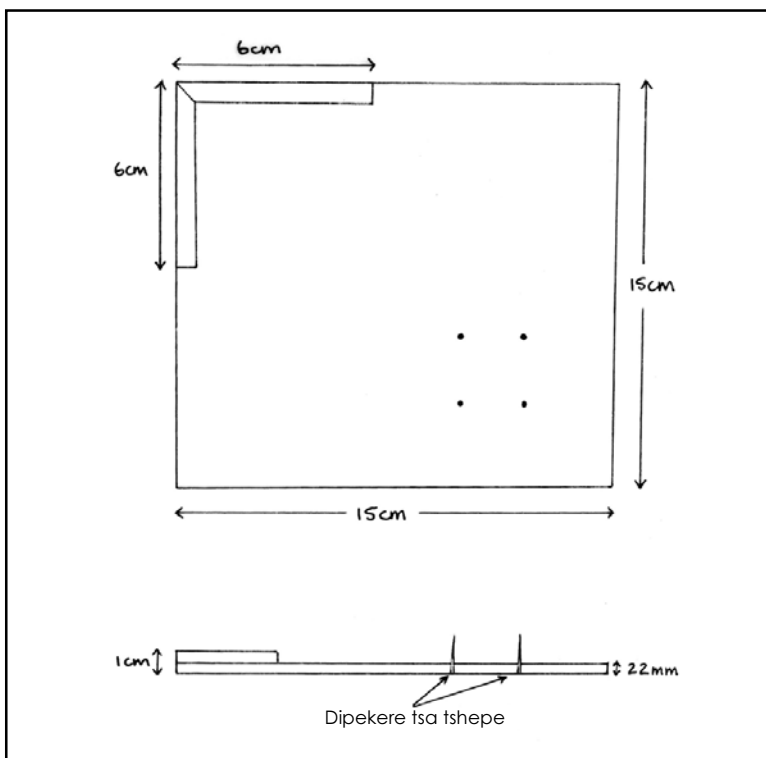

Dintlha tsa ho metha le tsa bothekeniki bakeng sa boto ya ho tlotsa le ho kgabela

Ka moo o lokelang ho etsa mohele o moholo bakeng sa haeba motho a sokola ho tshwara mohele o motshesane

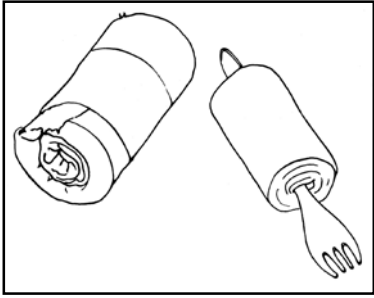

O hloka:

- Kgaba kapa fereko
- Sepontjhe sa boholo ba 6 cm x 10 cm se tiileng (ho ipapisitse le hore kgaba e telele bo bokae le hore na mohele o tlameha ho ba motenya bo bokae)
- Elastoplast/theipi e tlammellang

Mokgwa:

1. Thatela sepontjhe ho potoloha mohele wa kgaba kapa fereko ho etsa hore sebaka sa mohele se be seholwanyane.
2. Tlamella ka Elastoplast/theipi e tlammellang.



Nka thusa motho ya jwalo ho hlapa meno a hae jwang?



1. Dudisa motho eo kapele ho seipone.
2. Motho eo o tlameha ho dula a otlohohile.
3. Emisa hlooho ya hae e otlohohile.
4. Tlohela letsoho le fokolang hore le dule hodima tafole mothating wa sekotlolwana sa metsi.
5. Ema ka mora motho eo mme o shebe ka seiponeng.



Se ke wa qethola hlooho ya motho eo kapa wa e sekamisa.

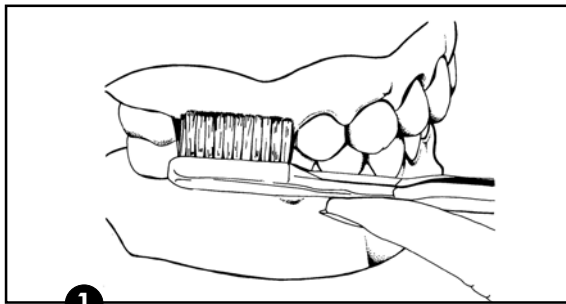

1

Tshwara borashe ka tshekamo ya sekogutlo sa 45° (bo sekame hanyane) ho ella mareneneng le menong a motho eo.

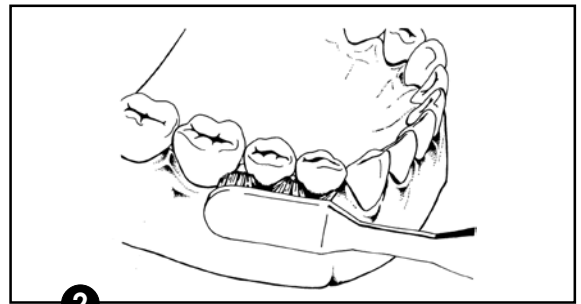

2

Hlatswa ka ho etsa methinya e menyane.

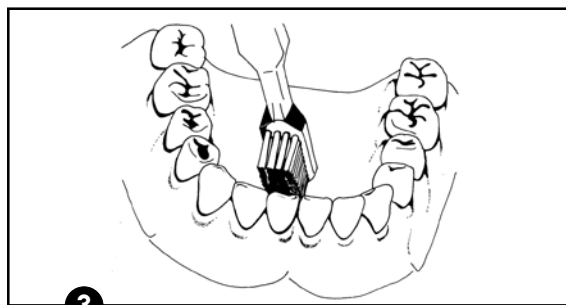

3

Hlatswa meno bobedi ka hare le ka ntle ho meno.

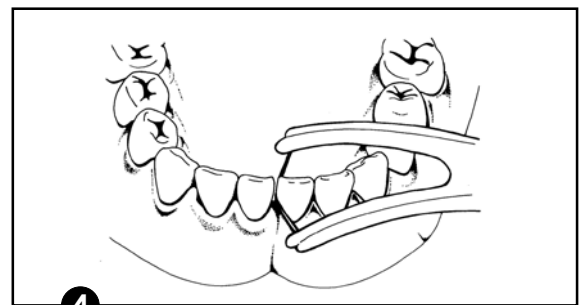

4

Sebedisa sesebediswa sa ho tshwarella kgwele ya folose ho folosa meno. Sheba mohlala wa ho folosa meno ka tlase mona.



Nka thusa motho eo ho tshwara borashe ba meno jwang haeba letsoho la motho eo le fokola haholo?

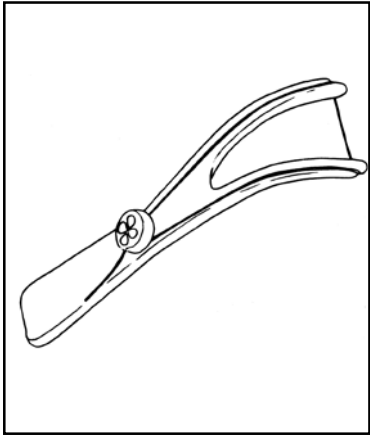

Mohlala wa sesebediswa sa ho tshwarella kgwele ya ho folosa meno.

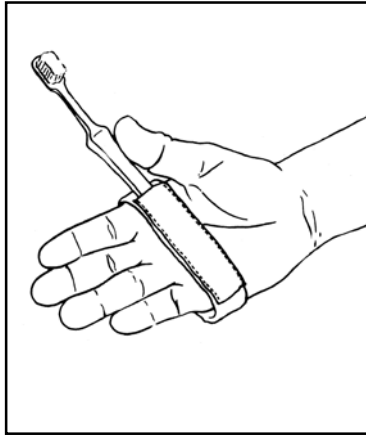

Mohlala wa sesebediswa sa ho tshwara borashe.

Sesebediswa se bonolo sa ho tshwara borashe se ka etswa ka ntho e matla, e sa saroloheng jwalo ka lesela la ditulo. Etsa lerapo le hokelang letsohong ka Velcro. Rokella pokotho karolong e seatleng sa letsoho moo borashe ba meno bo ka kenang. Pokotho e tlameha ho tiya ho potoloha borashe ba meno e le hore borashe ba meno bo dule bo tsitsitse.

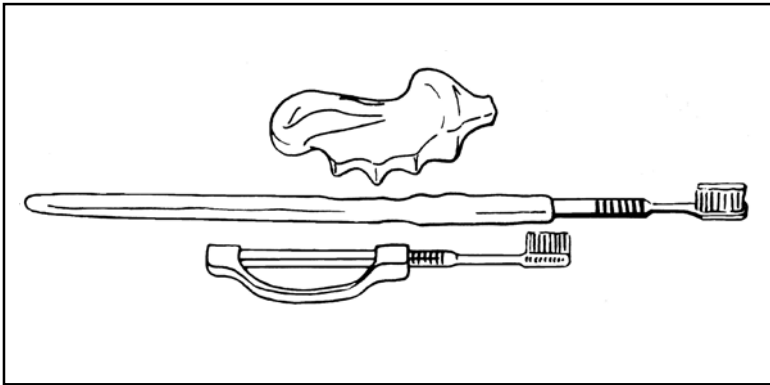

Dikgetho tse ding tsa ho ntlafatsa mohele di kenyeletsa:

- Sebedisa mohele o moholwanyane. O ka etsa mohele o moholwanyane ka bowena jwalo ka ha ho hlalositse ka hodimo mona, kapa wa o reka lebenkeleng le kgethehileng.

KAPA

- Wa sebedisa mohele o motelele. Sena se sebetsa hantle bakeng sa motho ya sokolang ho phahamisetsa matsoho a hae hodimo ho lekana.

KAPA

- Reka sesebediswa se tshwarang borashe ho tswa lebenkeleng la disebediswa tse kgethehileng.

6. Tlhokomelo ya lehetla

Batho ba bangata ba otlilweng ke seterouku ba ba le lehetla le bohloko le/kapa le sata-letseng. O ka thibela sena ka ho tshwara lehetla ka tsela e nepahetseng.



Tsela e nepahetseng ya ho tshwara sephaka se fokolang kapa se holofetseng ke efe?

- Tshehetsa motho eo karolong ya dikgopo ho mo thusa ho theheha, ho dula, ho ema, jwalo jwalo.
- Se ke wa hula sephaka sa motho eo.
- Pele o hlatswa kapa o apesa sephaka se fokolang, kamehla etsa bonnete ba hore lehetla le lokolohile (le kgona ho ka tsamaya).

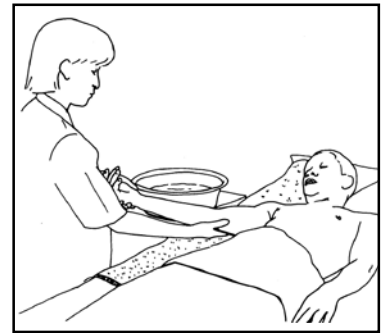
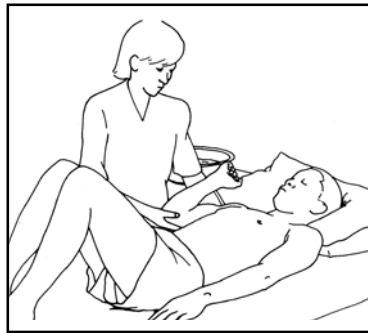

1. Haka kgarafu ya lehetla lehlakoreng le fokolang ka letsoho la hao.
2. Hulela kgarafu ya lehetla ha bonolo lehlakoreng le pele.
3. Pheta sena makgetlo a mmalwa ho fihlela lehetla le tsamaya ka bolokolohi.
4. Boloka dikgarafu tsa ma-hetla di tobile pele.
5. Tshwara sephaka ka hodimonyana ho setswe feela mme ka hloko sothela sephaka le letsoho ka ntle.
6. Emisa haeba motho eo a utlwa bohloko.
7. Se ke wa tshwara letsoho kapa karolo e tlase ya sephaka kaha sena se ka baka bohloko kapa tshenyeho setsweng.
8. Hang ha sephaka se tsamaya ka bolokolohi, phahamisetsa sephaka se hodimo sa motho eo hodima setswe mme o ise sephaka thoko le mmele.
9. Otlolla setswe.
10. Jwale tsamaisetsa lenonyeletso la lehetla ka hloko hodimo le/kapa lehlakoreng bakeng sa ho apeswa kapa ho hlapiswa.



Le ka mohla o se hule sephaka se fokolang.



Ke lokela ho etsang ka lehetla ha ke fetola motho eo betheng?

- Pele o fetolela motho lehlakoreng la hae le fokolang, kgwehlisa kgarafu ya lehetla ka tsela e tshwanang jwalo ka ha ho boletswe ka hodimo mona, ebe o le hulela pele (dikgopong).
- Tshehetsa sephaka le lehetla ka tsela e tobileng pele. Ha o ntse o bolokile boemo bona, motho eo a ka theheha lehlakoreng le fokolang.
- Se ke wa tlohela motho eo ho robala hodima lenonyeletso la lehetla.



Nka tshehetsa sephaka jwang ha motho eo a ntse a dutse?

- Tshehetsa lehetla pela lehlakore la mmele ho boloka lenonyeletso la lehetla le le bodulong bo bolokehileng. Tshehetso e tlameha ho phahama ho lekana hore mahetla a dule ka tsela e batsi.
- Haeba tshehetso e le tlase haholo kapa hole haholo le mmele, sephaka se hodimo se ka pshemoha sekotjaneng sa lenonyeletso mme ka hona lenonyeletso la lehetla le tla saroloha le ho buleha mme sena se bake bohloko.



Hobaneng ke sa lokela ho sebedisa kgetsi ya letsohwana?

Kgetsi ya letsohwana e etsang hore sephaka se be ka pele ho mmele se tla baka hore sephaka se satalle le ho feta, se tla kgutsufatsa mesifa e potolohileng lehetla, mme se tla etsa hore ho se kgonehe ho tsamaisetsa letsoho lehlakoreng la mmele. Sena se tla baka hore mesifa e petetswe ha sephaka se phahamiswa bakeng sa ho apeswa le ho hlapiswa. Kgetsi ya letsohwana hape e ka baka hore senoko sa letsoho se kobehe le ho satalla, mme hape e ka baka hore letsoho le ruruhe.



Hobaneng le ka mohla ke sa lokela ho fa motho eo bolo e petetwang ka seatla?

Le ka mohla o se fe motho eo bolo hore a e petete ka seatla sa letsoho le fokolang hobane sena se tla eketsa ho satalla ha letsoho mme ho tla etsa hore ho be thata le ho feta hore a fuparolle menwana hore o hlapise le ho omisa letsoho.



Kwetliso e ntle ke efe bakeng sa lehetla?

Kwetliso e bonolo ho boloka lehetla, setswe le senoko sa letsoho di tsamaya ka bolokolohi le ka boiketlo

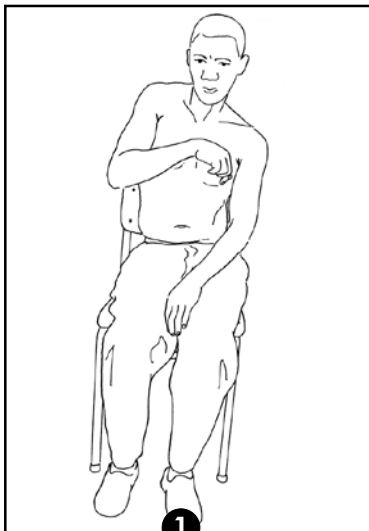

1

Sebedisa setulo se tiileng se nang le boitshetleho bakeng sa tshehetso. Dumella motho eo hore a dule ka tsela eo dirao tsa hae di thetsitseng boitshetleho ba setulo mme maoto a hae a thetsitse fatshe.



2

Jwale dumella motho eo ho kobehele pele mme a tlise setswe se fokolang butle-butle ka hara lengwele le fokolang.

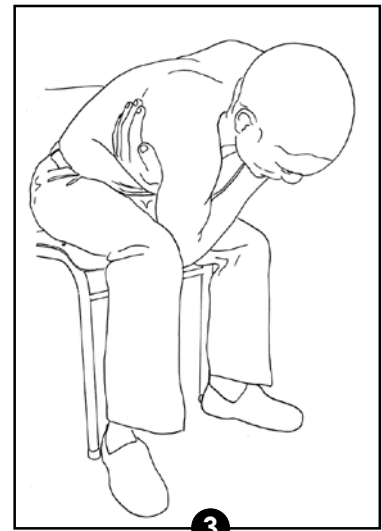

3

Motho eo o tshwara kgarafu ya lehetla le fokolang ka letsoho le matla ka hore a nanabele ka tlasa lehafi kapa ka hodima lehetla. Karolo e hodimo ya mmele e hulelwa tlase butlebutle ho ya lengweleng le matla. Pheta ho fihlela kgarafu ya lehetla e ile pele haholo ka moo ho ka kgonehang.

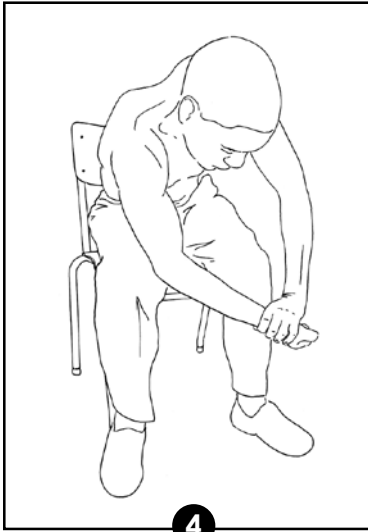

4

Motho eo o tlohela mmele wa hae o kobehehse pele, ebe o nka letsoho le fokolang ka senoko, mme a qale butlebutle ho otlolela setswe hodima lengwele.



5

Otlolela sephaka butlebutle dipakeng tsa mangwele ho ella maotong ho fihlela setswe se otlolohile ka moo ho ka kgonahalang.

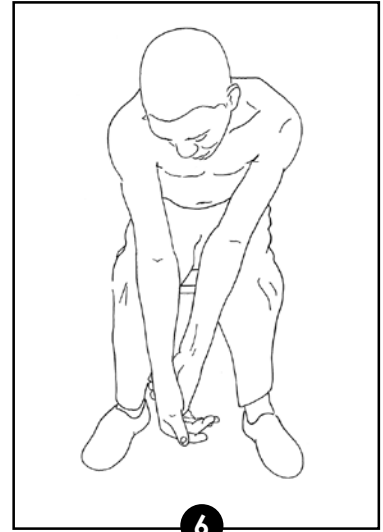

6

Haeba ho kgoneha, tlohella motho eo ho otlolohela fatshe.

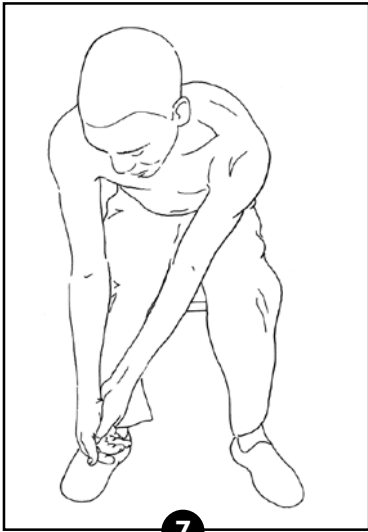

7

Jwale dumella motho eo hore a ritsisetse diphaka tsa hae lehlakoreng ho fihlela di le mahlakoreng a mabedi a lengwele le fokolang. Matsoho a tlameha ho dula a atamelane ka hohle ka moo ho ka kgonehang le leoto.

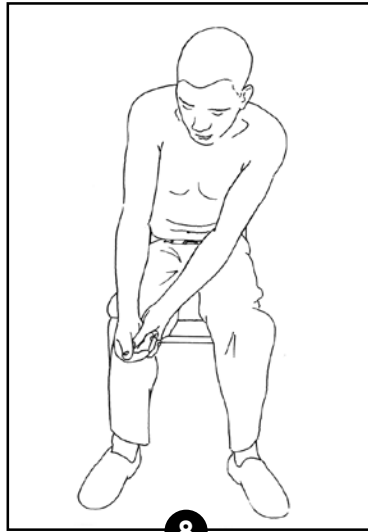

8

Qala ho ritsisetsa matsoho hodimo ho fihla tlhafung e fokolang.

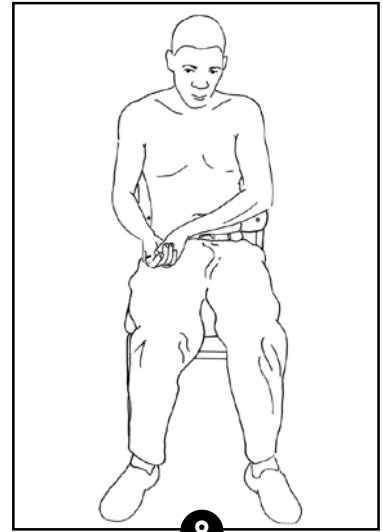

9

Tswela pele ho ritsisetsa matsoho hodimo ho tla fihla seropeng se fokolang.

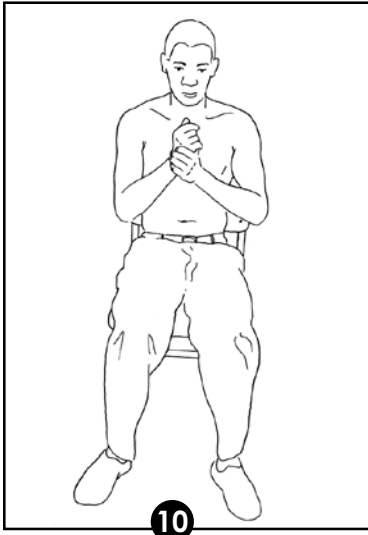

10

Tlisa matsoho hodimo bohareng ba mmele mme o a ritsisetse hodimo ho fihla sefubeng.

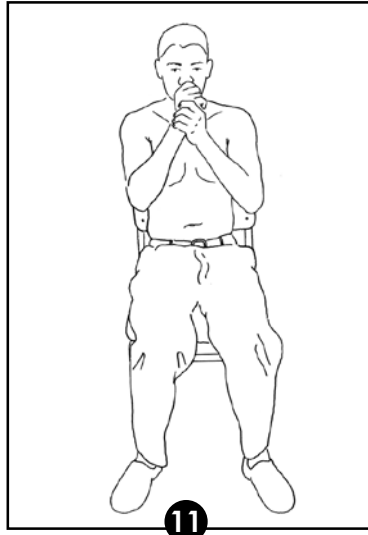

11

Jwale motho eo o lokela ho ritsisetsa matsoho a hae hodimo ho fihlela a ithetsa nko. Tswela pele ha feela ho se na bohloko.

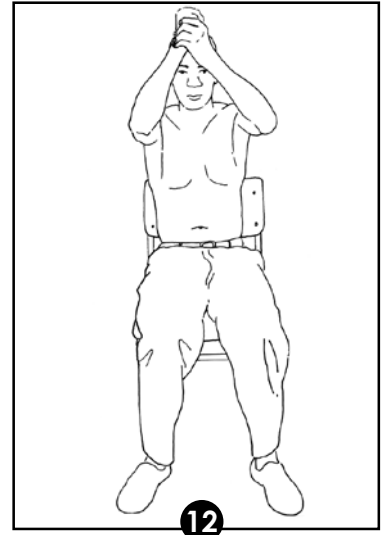

12

Ritsisa ho ya hodimo hape ho fihlela ka hodima hlooho. Tswela pele ha feela ho se na bohloko.

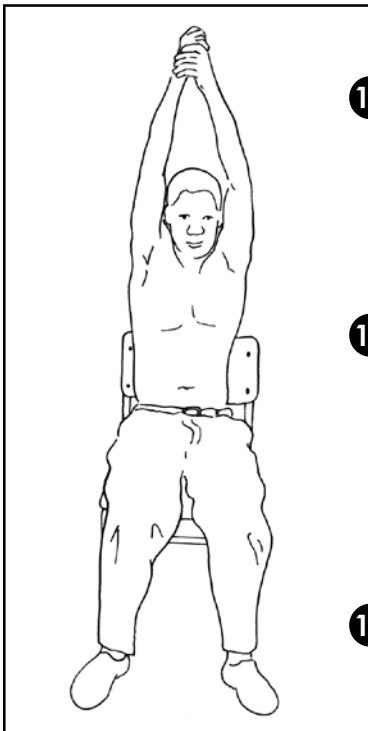

13

Haeba lehetla le se bohloko kapa ho satalla, motho eo o flameha ho otlolela diphaka tsa hae hodimo ka hohle ka moo a ka kgonang ntle le ho baka bohloko.

14

Pheta kwetliso ena makgetlo a mahlano ho fihla ho a leshome sesheneng ka nngwe ka letsatsi, bonyane ha nngwe ka letsatsi. Dumella motho eo hore a otlole manonyeletso a hae haholwanyane le ho feta lekgetlo le leng le le leng ha le etsa boikwetliso.

15

Se ke wa tswela pele ho otlolla haeba ho na le bohloko. Haeba ho na le bohloko, emisa ho otlolla mme le phete e meng ya mehato ya pejana ya boikwetliso.

7. Ho tsamaiswa betheng

Leano le akaretsang la ho tsamaisa:

- Le ka mohla o se hule sephaka kapa leoto.
- Kamehla hlalose tsa motho eo seo o batlang ho se etsa.
- Kopa motho eo ho o thusa ka hohle ka moo a ka kgonang.
- Dula o atametse motho eo ntle le ho mo okamela haholo.
- Koba mangwele a hao mme o otlole mokokotlo wa hao.



Batho ba babedi ba ka tsamaisa motho ya sa kgoneng ho itshisinyanya ho hang jwang?

Betheng e tlase

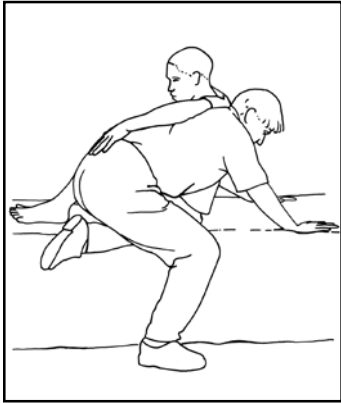

1. Dudisa motho eo mme o kobe mangwele a hae.
2. **Bahlokomedi bobedi ba tobela motho eo mme ba kobe mangwele a bona a haufi le yena hore a kgumame lehlakoreng la bethe.**
3. Bahlokomedi ba emise mahetla a bona kgahlanong le lehlakore ka leng la mmele wa motho eo, ka tlasana feela ho mahafi a hae. Motho eo a ka beha sephaka sa hae se matla hodima mokokotlo wa mohlakomedi e mong.
4. Bahlokomedi ba tlameha ho ba sedi hore ba se sutuletse mahetla a bona mahafing a hae.
5. Bahlokomedi ba itshehetsa ka matsoho a bona ka thokothoko le motho eo.
6. Bahlokomedi ba phuthela matsoho a bona ho kopa dirope tsa motho eo haufi le dirao.



7. Bahlokomedi bobedi ba petetsa mahetla a bona kgahlanong le mmele wa motho eo.
8. Bahlokomedi ba kopa diphaka tsa bona tse haufi ka ho fetisisa le motho eo maotong a hae haufi le dirao.
9. Bahlokomedi ba netefatsa hore ba tshwere ka ho tiya, mme ba otlole maoto a bona a ka ntle, ba phahamise le ho tsamaisa motho eo.
10. Haeba motho eo a le mmele o moholo kapa a le boima, ho fapana le hore a itshellehe ka letsoho le leng, mohlakomedi a ka kenya letsoho leo tlasa dirao tsa motho eo mme a thuse ho phahamisa boima.

Betheng e phahameng

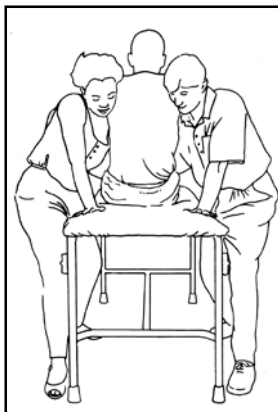

1. Dudisa motho eo mme o kobe mangwele a hae.
2. Bahlokomedi ba ema lehlakoreng ka leng la bethe, ba tobela motho eo.
3. **Maoto a bahlakomedi a tlameha hore a arohane ka sebaka se lekanang le bo-phara ba mahetla, mme leoto le kamorao le bapile le mmele wa motho eo, ha lengwele le kobehile hanyane. Leoto la bona le ka pele le tlameha ho thintshetswa lehlakoreng la moo a iswang teng.**
4. Bahlokomedi ba emisa mahetla a bona kgahlanong le mmele wa motho eo, ka tlasana feela ho mahafi, ba hlokometse hore ba se sutuletse mahetla a bona ka mahafing a hae. Motho eo a ka beha sephaka sa hae se matla hodima mokokotlo wa mohlakomedi e mong.
5. Bahlokomedi ba itshehetsa ka matsoho a bona a thokothoko le motho eo.



6. Bahlokamedi ba phuthela matsoho a bona ho kopa dirope tsa motho eo haufi le dirao.
7. Ho phahamisa motho eo, bobedi ba bahlokamedi ba petetsa mahetla a bona kgahlanong le mmele wa motho eo, ba kope maoto a motho eo ka matsoho a bona mme ba a tshware.
8. Haeba motho eo a le mmele o moholo kapa a le boima, ho fapana le hore a itshetlehe ka sephaka se seng, mohlakamedi a ka kenya letsoho leo tlasa dirao tsa motho eo mme a thuse ho phahamisa boima.

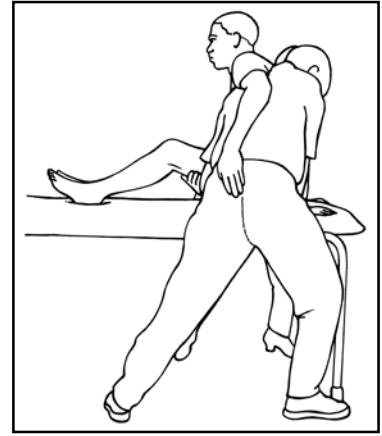

9. Bahlokamedi ba phahamisa le ho sisinya motho eo ka ho otlolla mangwele a bona mme ba fetisetsa boima ba bona maotong a ka pele le diphaka tse tsheheditseng.



Nka tlosa motho ya kgonang ho sisinyeha hanyane ka boyena jwang?e?

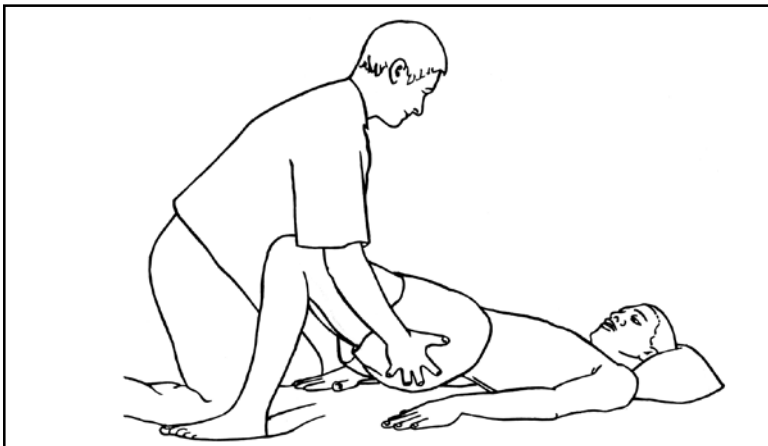

1. Kgumama ka lengwele le le leng betheng pela motho eo.
2. Thusa motho eo ho koba mangwele a hae.
3. Maoto a motho eo a dule a bataletse betheng. Beha lengwele la hao ka pele ho maoto hore maoto a se ritse.
4. Thusa ho phahamisa diqholo.
5. Ebe o thusa ho isa diqholo lehlakoreng.

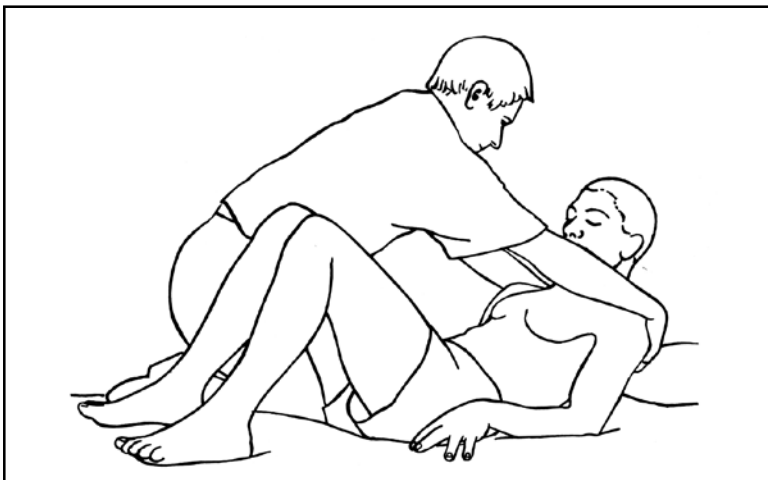

6. Tshwara motho eo ka ho tiya ka mora mahetla.
7. Kopa motho eo ho phahamisa hlooho ya hae.
8. Mo thuse ho phahamisa le ho tsamaisa hlooho le mahetla ka ho tshwara mahetla a hae.
9. **Se ke wa mo hula ka molala kapa diphaka.**
10. Tsamaela lehlakoreng ka ho qala pele o phahamisa le ho tsamaisa hlooho ya hae, ebe ho latela mahetla le diqholo.

Ka moo o lokelang ho thetela motho lehlakoreng le fokolang le le matla

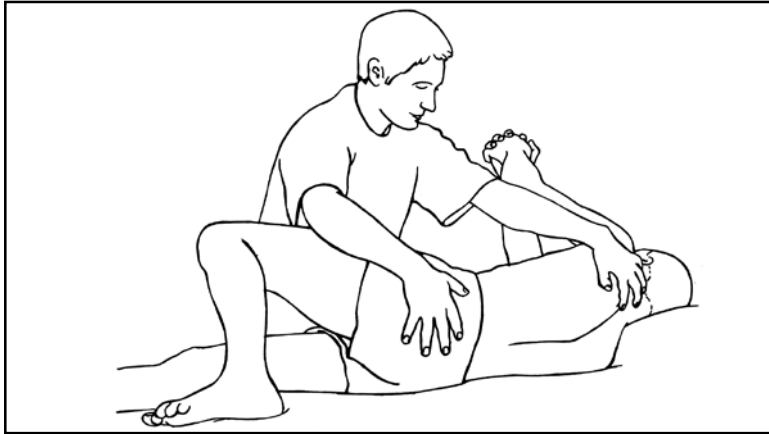

1. Kopa motho eo ho kopa-nya matsoho a hae mmoho kapa a tshware sephaka se fokolang tlasa senoko sa letsoho ka tsela eo monwana o motona o shebileng menwaneng. Motho eo o tlameha ho otlolela kgarafu ya lehetla le fokolang pele.
2. Koba lengwele le tlamehang ho thetela, ebe o theta mmele.
3. Kopa motho eo ho phahamisa hlooho le mahetla.
4. Tshehetsa motho eo diqholong le kgarafung ya lehetla.

Ka moo o lokelang ho thusa motho ya robetseng hore a dule ka dirao

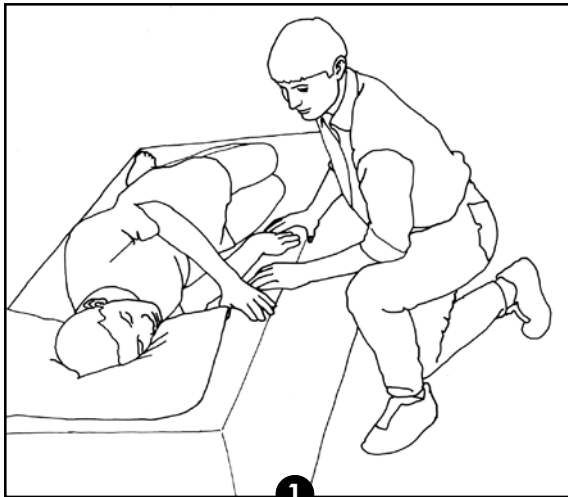

1 Thetela motho eo lehlakoreng.

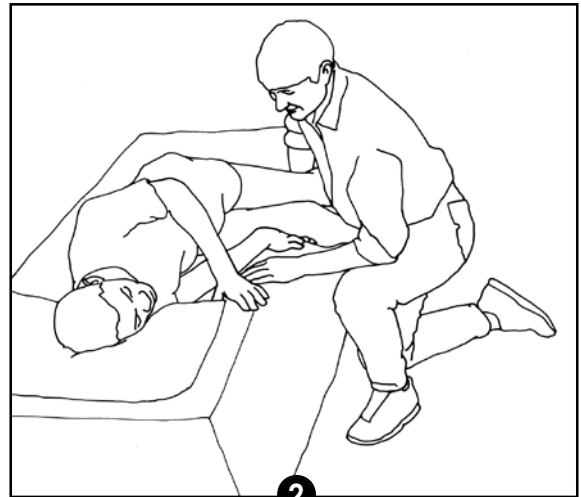

2 Dihela maoto a hae ntlheng ya bethe.

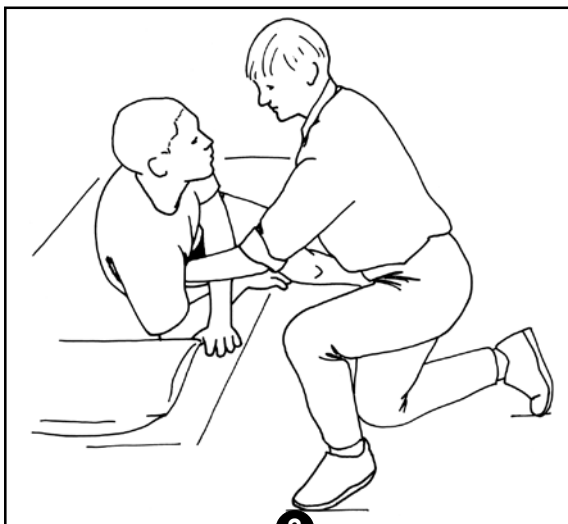

3 O ka fana ka tshehetso ka letsoho le le leng tlasa dikgopo le letsoho le leng lehetleng la lehlakore le leng, kapa o ka beha bobedi ba matsoho mahetleng. Hape o ka beha letsoho le le leng lehetleng la motho eo le letsoho le leng qholong.

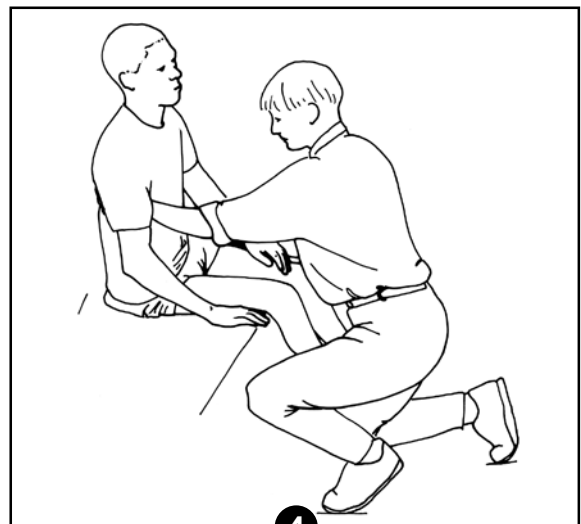

4 Kopa motho eo ho sutuletsa tlase betheng ka bobedi diphaka tsa hae hore a phahamise mmele. Motho eo ho hang ha a tshwanela ho itshwareletsa ho wena kapa ho hula molala wa hao.



Nka tataisa motho jwang hore a sisinyeha betheng ntle le ho fumana thuso?

Ka moo o ka mo tsamaisang ka teng betheng

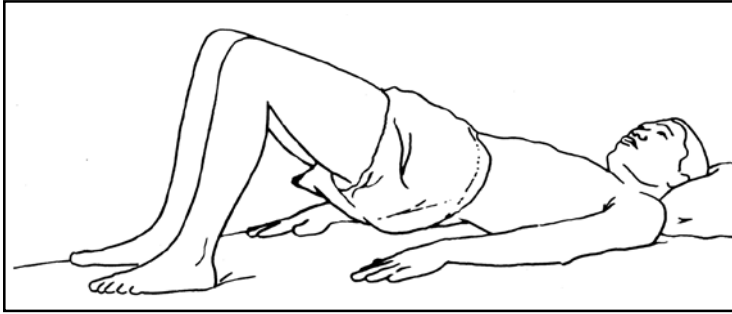

Kopa motho eo ho:

1. Koba mangwele a hae.
2. Beha maoto a hae fatshe a bataletse.
3. Phahamisa diqhoho tsa hae ka ho sutuletsa fatshe ka maoto a hae.
4. Suthela lehlakoreng kapa o sutuletse hodimo.
5. Phahamisa hlooho le mahetla a hae mme o mo tsamaise.

Ka moo o lokelang ho mo theta ka teng betheng

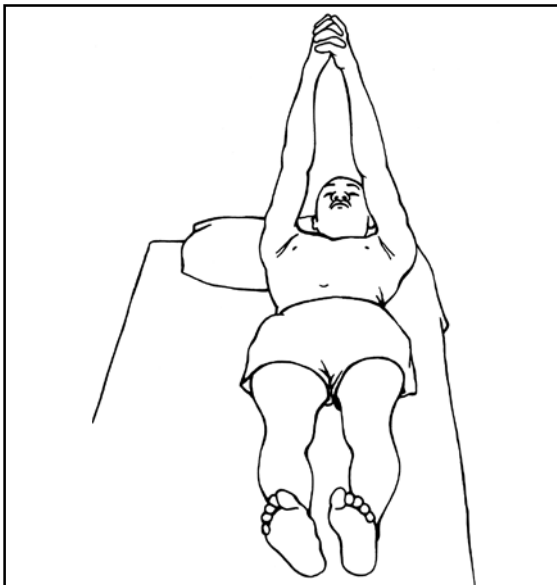

Kopa motho eo:

1. Ho ya lehlakoreng la bethe jwalo ka ha ho hlalositse ka hodimo mona.
2. Kopa matsoho a motho eo mmoho kapa o tshware sephaka se fokolang tlasa senoko sa letsoho ka tsela eo monwana o motona o shebileng menwaneng e meng ya letsoho.

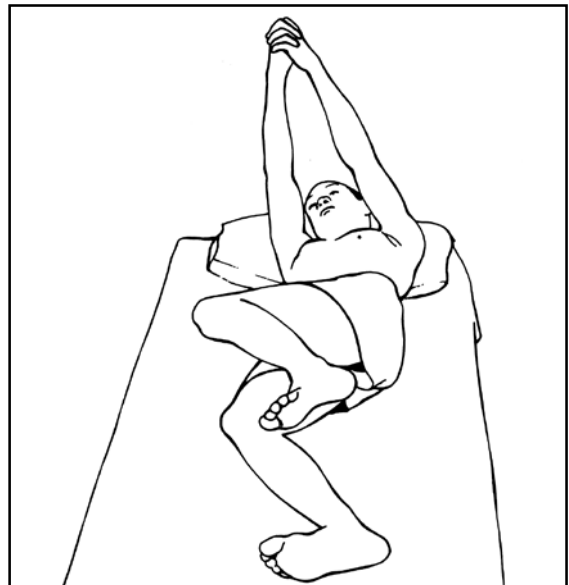

3. Phahamisetsa diphaka tsa hae hodimo, mme o hulele lehetla le fokolang pele butlebutle.
4. Phahamisa hlooho, mahetla le leoto.

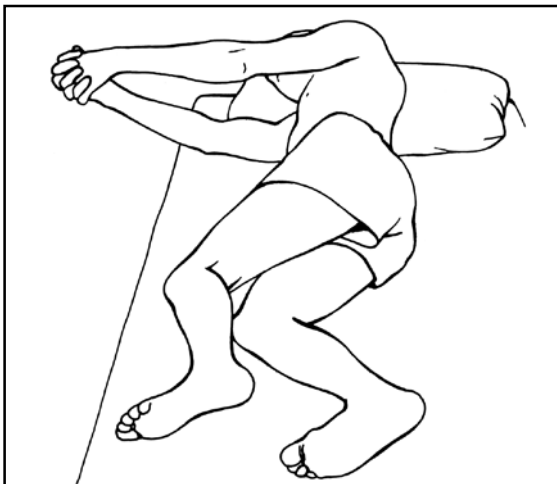

5. Mo thete.

Ho dudisa ka dirao

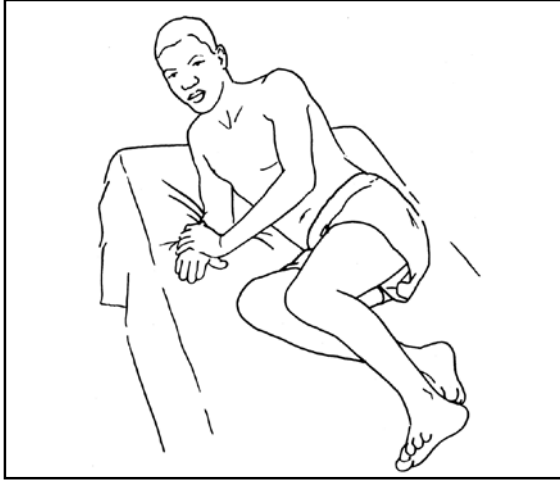

Kopa motho eo ho:

1. Thetehela lehlakoreng.
2. Haka leoto la hae le matla kamora le fokolang ebe o ftoletsa maoto ntlheng ya bethe.

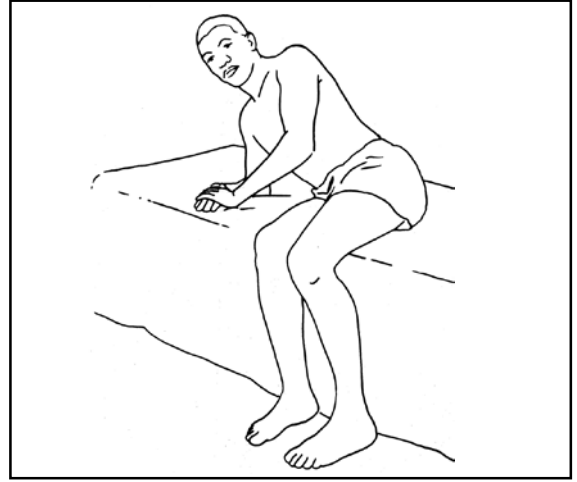

3. Setlela ka setswe ka ho sutuletsa tlase ka matsoho a mabedi.



4. Tswela pele ho sututsa ka bobedi ba matsoho ebe o otlolla ditswe.

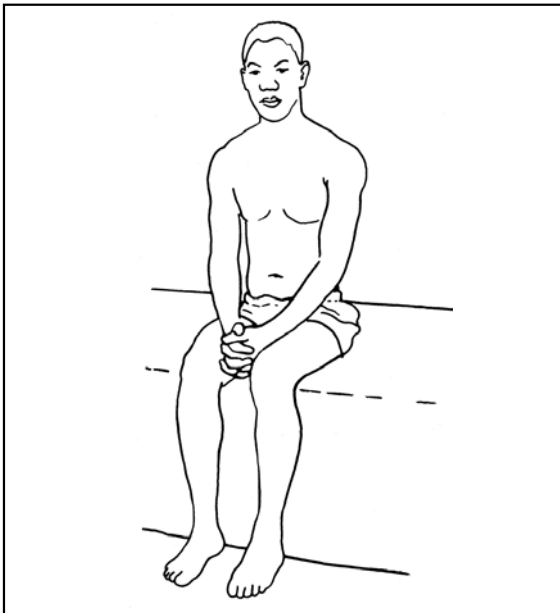

5. Otlolla ka ho phethahala mme o etse bonnete ba hore o dulella morao ho lekana hore bethe e tshehetse dirope ka ho phethahala.

8.

Diphetiso

(ho floswa betheng ho ya setulong le ho kgutlela betheng)

Maano a akaretsang:

- Beha hwiletjhere kapa setulo pela bethe.
- Notlela mariki a hwiletjhere.
- Mohlokamedi ya moteletsana kapa ya matla ho feta o tlameha ho ba ka morao.
- Bahlokamedi ba tlameha ho sebetsa mmoho.
- Etsa qeto e sa le pele hore ke mang ya tla fana ka ditaelo, le hore na ditaelo tseo e tla ba dife.
- Bontsha hore na le tla qala ho phahamisa neng, le phahamisa ha le badile ho fihla ho 'tharo' ka ho re: 'Nngwe, pedi, phahamisa.'



Batho ba babedi ba tlameha ho tsamaisa motho ya fokolang haholo jwang ho mo flosa setulong ho ya betheng e tlase?



Bodulo ba motho;

1. Motho o phutha matsoho a hae.



Sebaka sa mohlakomedi ya ka morao:

2. Mohlokamedi ya ka morao o theolela diphaka tsa hae dipakeng tse hodimo tsa motho eo le dikgopo.
3. Mohlokamedi o tshwara bobedi ba diphaka tsa motho eo tse haufi le diitse.



Sebaka sa mohlakomedi ya ka pele:

4. Mohlokamedi e mong o kgumama kapa o kot-sama ka pele ho bethe, leoto le leng le le ka pele ho le leng.
5. Mohlokamedi o beha diphaka tsa hae tlasa mangwele a motho eo le hodimo diropeng tsa hae, ka ho atameha haholo ka moo ho ka kgonehang ho dirao.
6. Maoto a motho eo a ka behwa seropeng sa mohlakomedi kapa karolo ya oona e ka nna ya be a se e dutse betheng.



Tshebetso ya mohlakomedi ya ka pele:

7. Mohlakomedi ya ka pele o phahamisa maoto a motho eo, a a tshwaretse haufi le mmele wa hae, mme a fetisetse mmele pele leotong le leng ho isa motho eo betheng.

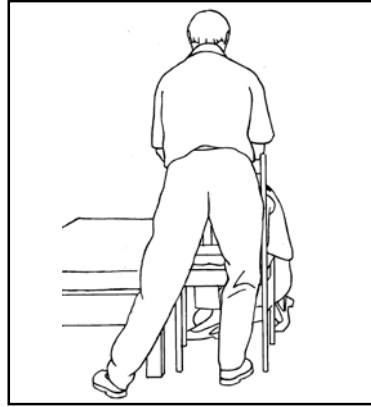

Tshebetso ya mohlakomedi ya ka morao:

8. Mohlakomedi ya ka morao o ema a takaladitse mme a kobehile hanyane, ebe o otlolla maoto a hae ho phahamisa motho eo. Mohlakomedi hape a ka nna a koba lengwele le atametseng ka ho fetisisa ho bethe hore le kgumame betheng.

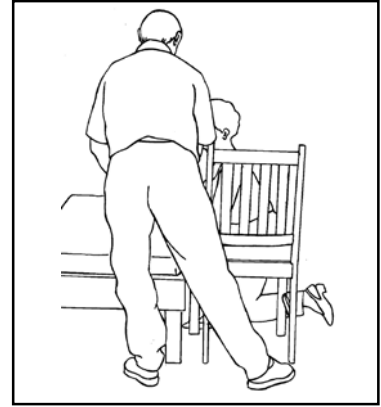

Tshebetso ya mohlakomedi ya ka morao:

9. Mohlakomedi ya ka morao jwale o fetisetsa boima ba hae leotong le haufi ka ho fetisisa ho bethe mme a fetisetse motho eo betheng.

Latela mehato e boletsweng ka hodimo mona ka tsela e kgutlelang morao hore o kgutlisetse motho eo setulong.



Batho ba babedi ba flameha ho flosa motho ya fokolang haholo jwang ho mo flosa setulong ho ya betheng e phahameng?



1. Bahlakomedi ba ema jwalo ka ha ho hlahositswe ka hodimo mona. Mohlakomedi ya ka pele a ka kgumama kapa a kotsama, ka tsela eo leoto le leng le leng ka pele ho le leng.
2. Maoto a motho eo a dula hodima serope sa mohlakomedi.



3. Mohlakomedi ya ka morao o phahamisa jwalo ka ha ho hlahositswe ka hodimo mona. Haeba mohlakomedi a le mokgutshwane, a ka ema setuping se tiileng.
4. Mohlakomedi ya ka pele o phahamisa dirao tsa motho eo le maoto ka hore a eme.

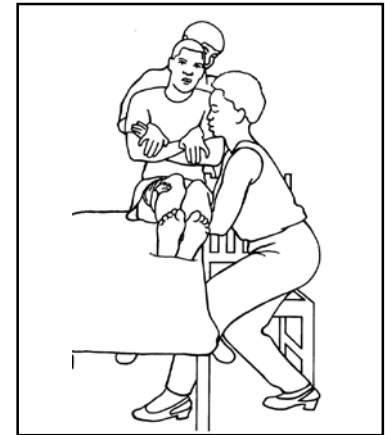

5. Mohlakomedi ya ka morao o fetisetsa boima ba hae leotong le haufi ka ho fetisisa ho bethe mme a fetisetse motho eo betheng.
6. Mohlakomedi ya ka pele o atamela pele ka leoto la hae le ka morao mme o isa maoto a motho eo le dirao betheng.

Latela mehato ena ka tsela e kgutlelang morao hore o kgutlisetse motho eo setulong.



Motho a le mong a ka thusa motho ho tloha betheng ho ya setulong jwang?

Maano a akaretsang ke ana:

- Thusa motho ho isa dirao tsa hae pele setulong kapa betheng.
- Beha maoto a hae a arohane hanyane kamora mangwele.
- Kopa motho eo ho emisa mokokotlo wa hae o otlohile, a kobehe lethekeng mme a inamisetse hlooho le mahetla a hae pele hodima mangwele.
- Eba sedi hore o se atamele haholo ho motho eo. Isa mmele wa hao morao ha a kobe-hela pele.
- Kopa motho eo ho ema a otlohile hang ha dirao tsa hae di phahama.



Ka moo o lokelang ho tsamaisa motho a emeng ha a hloka tshehetso lengweleng le fokolang?

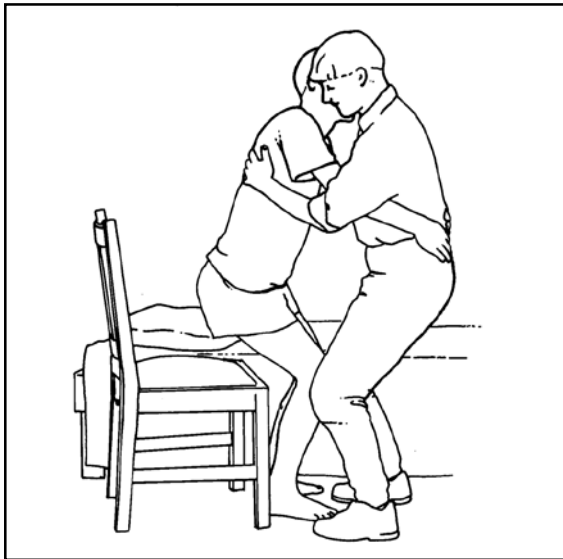

1. Beha setulo pela bethe.
2. Tshehetsa lengwele le fokolang mahla-koreng bobedi ka mangwele a hao. Se ke wa thibela lengwele le ka pele.

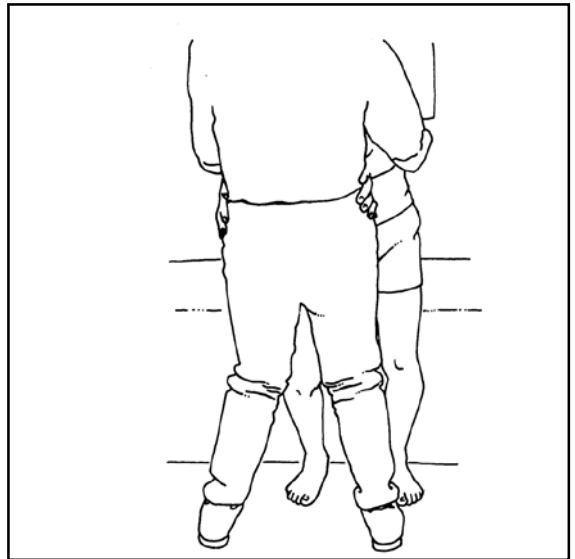

3. Tlisa motho eo pele le hodimo ka ho isa mahetla pele le hodimo.
4. Sothehela betheng mme o dudise motho eo butlebutle.

Ka moo o lokelang ho tsamsaisa motho ya fokolang, ya boima kapa ya molelele ka boto e ritsang

Sebedisa sekotwana sa lepolanka hore motho eo a ritsetse ho sona. Etsa bonnete ba hore bokahodimo le methati ha di na metsu e hlabang. Sebedisa boto ha motho a apere feela.

Dintlha tsa dithekanyo le tsa sethekeniki bakeng sa boto ya ho fetisa

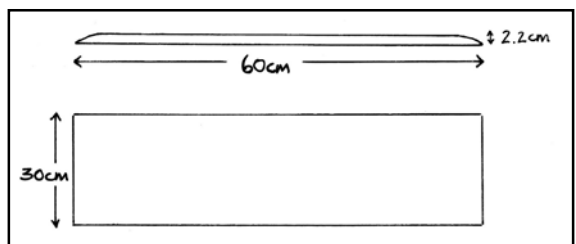
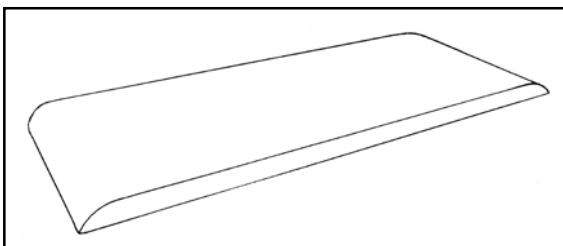



1. Emisa hwiletjhere pela bethe ka tsela e sekameng hanyane. Ntletla mariki a hwiletjhere. Tlosa boitshwareletso bo lehlakoreng la bethe.
2. Ema ka tsela eo o neng o tla ema ka yona ha o tsamaisa motho eo a eme.
3. Kobela motho eo thoko le bethe mme o kenye boto tlasa dirao tsa hae haufiufi le bethe.
4. Beha boto ka tsela eo e thehang borok-go dipakeng tsa bethe le hwiletjhere.
5. Kopa motho eo ho emisa mokokotlo wa hae o otloohile, mme a inamisetse hlooho le mahetla a hae pele hodima mangwele.
6. Ritsisa dirao tsa motho eo ha boima ba hae bo phahamiswa botong.
7. Haeba motho eo a fokola, mo suthise sebaka se sekgutshwane feela. Pheta sena ho fihlela a dutse betheng.
8. Pheta mehato ena ka kgutliso ho kgutlisa motho eo hwiletjhereng.



Ka moo o lokelang ho thusa motho ya nang le diphaka tse matla le maoto a fokolang hore a tloswe

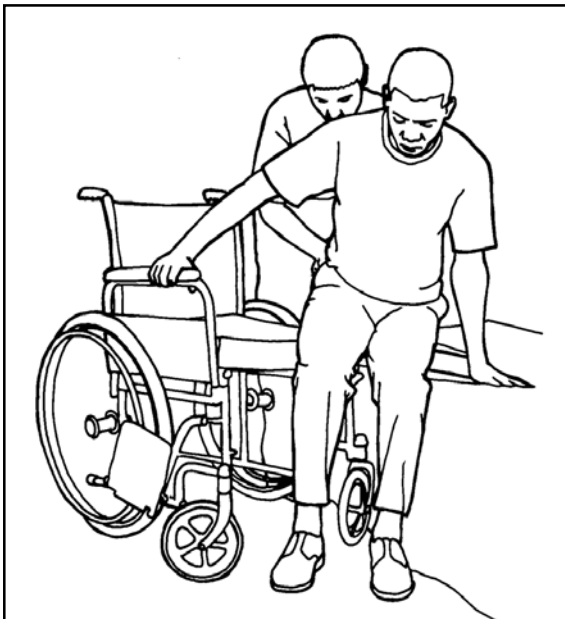

1. Kenya boto jwalo ka ha ho hlaositswe ka hodimo mona.
2. Eya ka mora motho eo ebe o kgumama betheng ka leoto le haufiufi le bethe. Beha leoto le leng la hao dipakeng tsa bethe le hwiletjhere.
3. Beha matsoho a hao diqholong tsa motho eo.



4. Kopa motho eo ho sutuletsa tlase ka matsoho a hae ebe o phahama le ho ritsisetsa dirao tsa hae lehlakoreng.
5. Mo thuse ho phahama le ho ritsisa dirao.
6. Pheta sena ho fihlela motho eo a dutse betheng kapa setulong.



Nka tataisa motho ya nang le maoto a fokolang le diphaka tse matla jwang hore a tlohe setulong ho ya betheng ntle le thuso?

Ka moo o ka fetisang motho eo ka boto

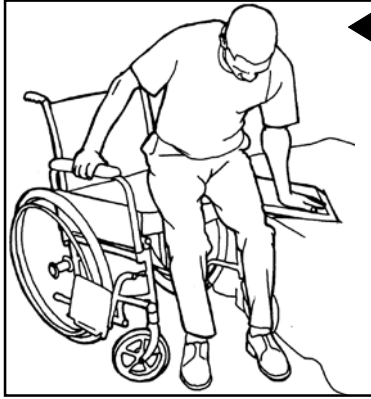

1. Kenya boto tlasa dirao.
2. Kobehela pele mme o jare boima ka maoto a hao.

3. Sutuletsa tlase ka diphaka.
4. Mo fetise ka ho ritsetsa hanyane ka hanyane lehlakoreng.
5. Se ke wa ema nako yohle.



Nka thusa motho ho ema jwang ka thuso e nyane?



1. Thusa motho eo ho ritsetsa ka dirao tsa hae ntlheng ya bethe.
2. Maoto a motho eo a tlameha ho arohana hanyane, a bapile mme a le ka mora mangwele hanyane.



kolang qholong ya hao. Haeba sephaka se sataletse kapa se le bohloko, se tlohele se lekette dipakeng tsa mangwele a motho eo.



4. Tshwara motho eo ka dikgarafu tsa mahetla mmeleng, e seng hodi-mo diphakeng. Tshehet-sa motho eo ka sephaka sa hao se tlase.

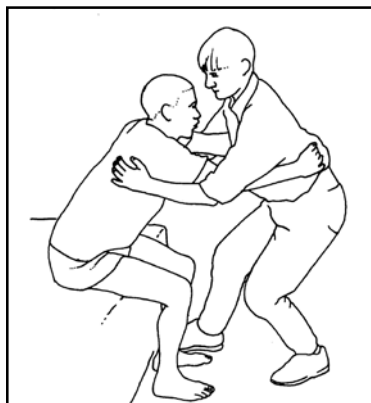

5. Tataisetsa mahetla a motho eo pele ka ho fetisetsa boima ba mmele wa hao leotong le ka morao.



6. Thusa motho eo ho ema. Mo dumelle ho iketsetsa bongata ba dintho ka moo a ka kgonang ka teng.



Nka tataisa motho jwang hore a eme ntle le ho fumana thuso?

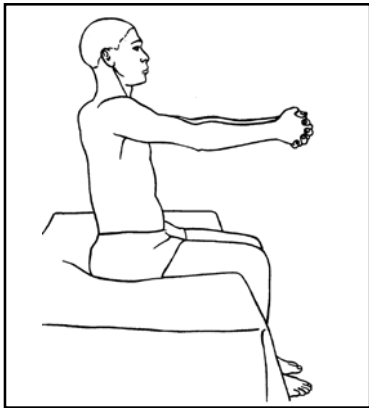

1. Dula o tsepame.
2. Kopa matsoho kapa o tshware sephaka se fokolang tlasana ho senoko sa letsoho ka tsela eo monwana o motona o shebileng menwaneng.

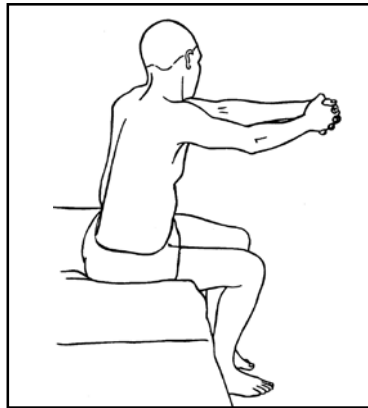

3. Mo ritsisetse pele ka dirao.

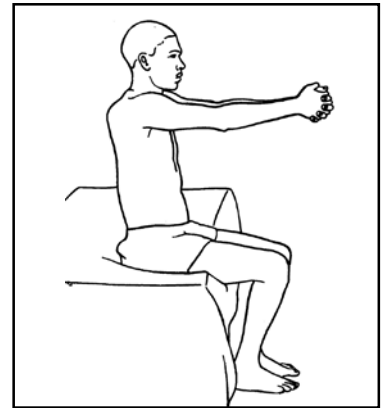

4. Emisa ntlheng ya bethe. Emisa maoto a motho eo a arohane hanyane, a bapile mme a le ka mora mangwele hanyane.

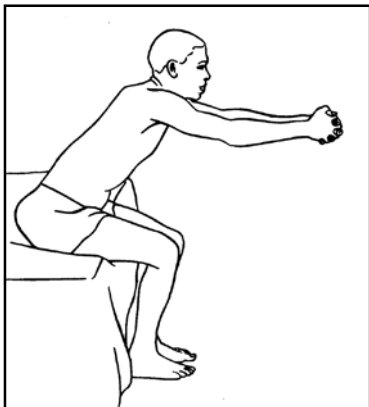

5. Kobehela pele ho tloha diqholong ho fihlela mahlata a le kapele ho mangwele le maoto. Nanabela pele ka matsoho ho thusa ho tisa boima pele.

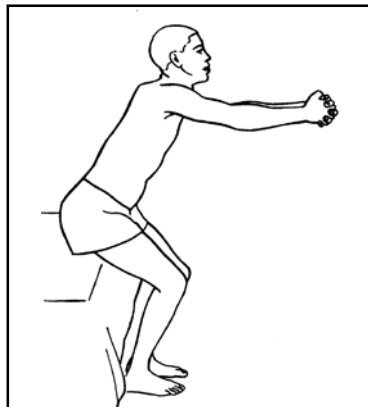

6. Qala ho phahamisa dirao mme o otlolle mangwele. Se ke wa sutuletsa mangwele kgahlanong le bethe kapa setulo.

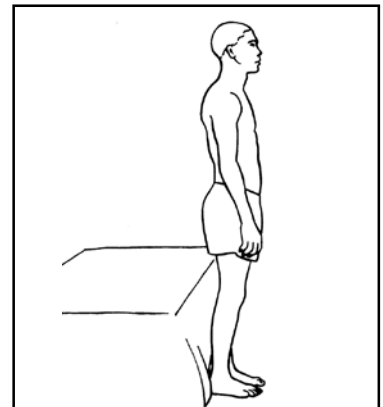

7. Ema o otlolohile.

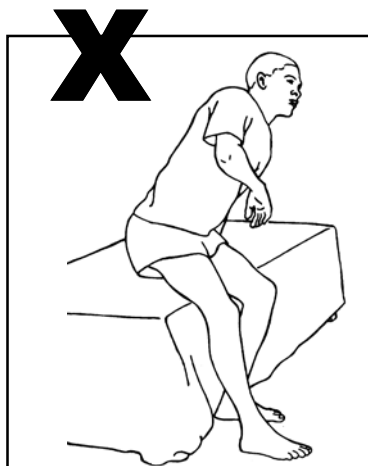

Le ka mohla o se eme ka ho sututsa o sebedisa letsoho le matla feela. Haeba motho eo a sebedisa lehlakore le matla la mmele wa hae feela, sena se tla baka hore lehlakore le fokolang le fokole le ho satalla le ho feta. O ka mpa wa otlollela matsoho bobedi pele mme a dule kgahlanong le boitshetleho ba setulo, lebotha kapa feneshara ho thusa.

9. Boithhokomelo



**Dumella motho eo ho iketsetsa
dintho tse ngata ka moo ho ka
kgonehang ka teng.**

Taolo ya senya le mala (ditlhoko tsa ho ya ntlwaneng)

Ho na le mabaka a mangata a hore ke hobaneng batho ba bangata ba ka sokola ho laola senya sa bona le mala. Motho ofe kapa ofe ya bang le bothata bona o tlameha ho bona ngaka, ya ka alafang a mang a mathata mme a fane ka moriana o tla ntlafatsa taolo.



Ka moo o lokelang ho thusa motho ho laola senya sa hae Hlalosetsa motho eo melawana e akaretsang, ka tsela e latelang:

- “Enwa dikgalase tse tsheletseng ho fihla ho tse robedi tsa metsi ka letsatsi. Tlatsa botlolo ya dilitara tse pedi ka metsi letsatsi le leng le le leng, mme o e behe ka sehatsetsing kapa haufi le bethe kapa setulo. Se ke wa nwa metsi a fokolang hobane feela o tshaba hore o tla intshetsa metsi.
- O se ke wa nwa letho nako ya bonyane hora e le nngwe pele o ya ho robala haeba o ntshetsa metsi dikobong.
- Eya ntlwaneng pele o ya ho robala le hanghang ha o tsoha feela hoseng.
- Kwahela materase ka lakane ya polasetiki, mme o kwahela lakane ya polasetiki ka thaole kapa koranta pele o e kwahela ka lakane ya lesela. Se ke wa robala kapa wa dula hodima lakane ya sekwahelo ya polasetiki.
- Eya ntlwaneng dihora tse ding le tse ding tse pedi. Eketsa nako ena ho fihla ho dihora tse ding le tse ding tse nne butlebutle.
- Mmala wa moroto o tlameha ho fifala hanyane feela ho feta metsi. Haeba o fifetse ho feta mona, o nka kapa o na le madi, eya tleliniking ho fumana tlhahlobo bakeng sa tshwaetso e ka bang teng. Moroto o nang le mmala o lefifi ka tlwaelo o bolela hore ha o nwe metsi a lekaneng.”

Haeba motho eo a kgwesa lethopo la ho rota (peipi le mokotlana):

- Kamehla hlapa matsoho a hao pele le ka mora hore o sebetse ka lethopo la ho rota.
- Qhala mokotlana kgafetsa.
- Se ke wa tlamehla mokotlana ka ho tiya haholo.
- Haeba ho se moroto ka mokotleng ka mora dihora tse nne, e ka nna ya ba peipi e thibane. Isa motho eo tleliniking.



Ka moo o lokelang ho thusa motho ya se nang taolo ya mala

- Ngaka e tlameha ho beha motho eo lenaneong la tshebediso ya mala haeba motho eo a sa be le boikutlo bo mo jwetsang hore o lokela ho ya ntlwaneng.
- Theha tlwaelo ya ho ya ntlwaneng, jwalo ka ho ya ntlwaneng hoseng ho hong le ho hong kamora dijo tsa hoseng.
- Dumella motho eo ho dula a otlohileng hodina setulo sa ntlwana kapa commode.
- Ho thibela ho siba:
 - Motho eo o tlameha ho nwa dikgalase tse tsheletseng ho fihla ho tse robedi tsa metsi ka letsatsi.
 - Motho eo o tlameha ho qeta nako e ngata ka moo ho ka kgonehang a sa robala betheng nakong ya motshehare.
 - Motho eo o lokela ho ba mafolofolo ka hohle ka moo a ka kgonang.
 - O tlameha ho ja dijo tse nang le ditlheberetsi, ho etsa mohlala ditholwana tse sa ebolwang, meroho, ditholwana tse omisitwang, borene, borotho bo bosootho le reisi e sootho.
- Isa motho eo tleliniking haeba a ba le letshollo le nkang ho feta matsatsi a mararo.



Pitsana ya ho ithusa betheng e lokela ho sebediswa jwang?



Sebedisa pitsana ya ho ithusa ya betheng bakeng sa ho ntsha metsi feela. Ere motho eo a dule a otlolohile bakeng sa ho ithusa.

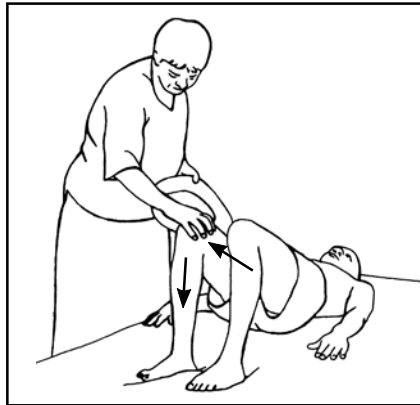

1. Tshehetsa lengwele le fokolang ka letsoho la hao ha motho eo a phahamisa diqholo tsa hae.
2. Hulela lengwele pele le tlase hodima leoto hore lengwele le se tlolele pele.

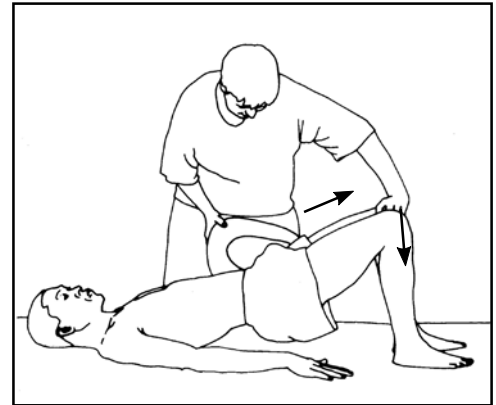

3. Kenya pitsana.



Mohlakomedi a le mong a ka thusa motho ho ya ntlwaneng jwang?



1

Haeba ho sa kgoneha ho beha hwiletjhere ka tshekamo ya sekgutlo sa dikgerata tse 90 ho ntlwana, e behe ka ho e sekamisa ka moo ho ka kgonehang. Tlamba mariki.



2

Thusa motho eo ho ritsetsa pele setulong le ho ema.

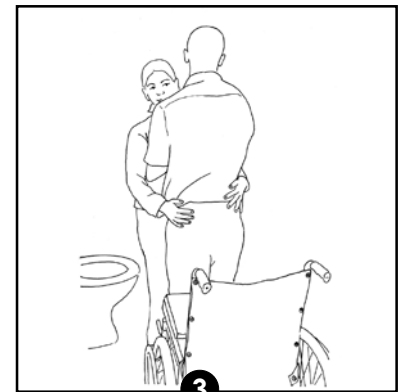

3

Tshehetsa lengwele le fokolang ka mangwele a hao. Theolela matsoho a hao diqholong tsa motho eo ho mo thusa ho tsitsa.

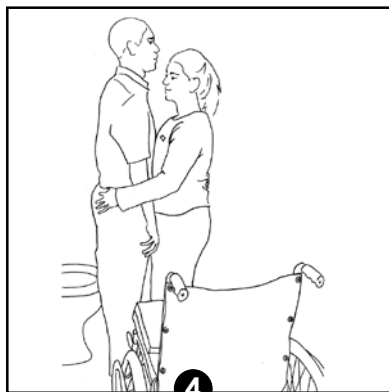

4

Thinya ho fihlela motho eo a eme ka pele ho ntlwana. Thusa ho mo hlobodisa.



5

Mo tataise butlebutle hore a dule fatshe.

? Motho a ka fetela ntlwaneng jwang ntle le thuso?



1. Tlamba mariki a hwiletjhere mme o kopanye matsoho mmoho ho ya pele setulong.
2. Kopanya matsoho mmoho.
3. Ema.



4. Thinya.
5. Beha matsoho a kopantsweng setulong bakeng sa tshehetso, haeba ho hlokeha.

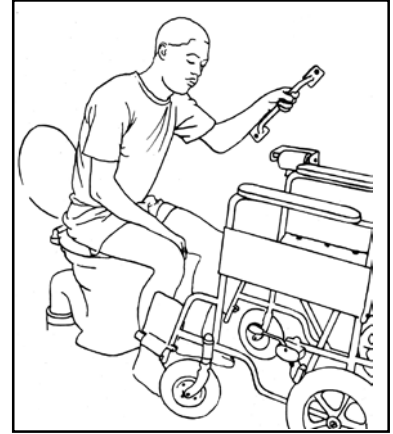

6. Dula fatshe ntlwaneng.
7. Haeba ho ema ntle le tshehetso ya letsoho ho sa kgonehe, sebedisa tshepe ya boitshwareletso mme o tlohele letsoho le fokolang hore le leketile dipakeng tsa maoto.

? Disebediswa tse ka thusang ka ho ya ntlwaneng



Setulo se phahameng haholwanyane sa ntlwana: Se sebetsa hantle bakeng sa batho ba balelele, batho ba nang le mathata a diqholo kapa mangwele, kapa haeba ntlwana e le tlase haholo.

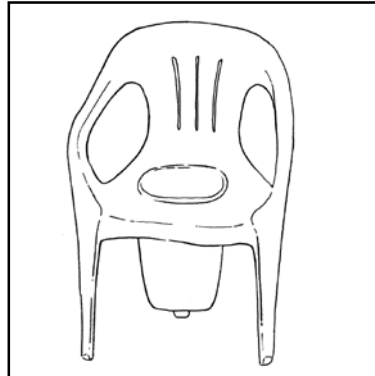

Setulo sa polasetiki se nang le lesoba setulong le nkgo ka tlase.

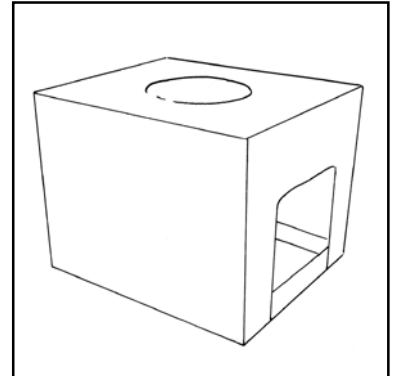

Etsa commode ka mapo-lanka.

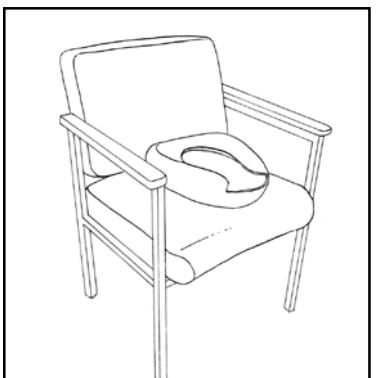

Sebedisa pitsana setulong se thata.



Sebedisa pitsana hwiletjhereng.

Ho hlapa



Ke lokela ho hlapisa motho ya betheng jwang?

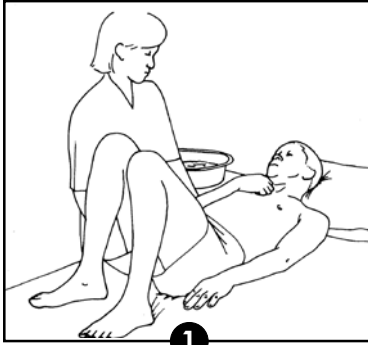

1

Ema ka lehlakoreng le fokolang.



2

Isa motho eo thoko le lehlakore la bethe ka ho phahamisa hlooho ya hae le mahetla, ebe o isa motho eo bohareng ba bethe.

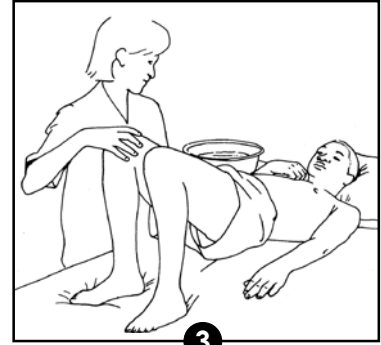

3

Kopa motho eo ho tsamaisa diqhoho tsa hae ka ho phahamisa dirao tsa hae ebe o ya bohareng ba bethe.



4

Lokolla lehetla pele o phahamisa sephaka. Haka letsoho la hao kgarafung ya lehetla ebe o hulela kgarafu ya lehetla pele butlebutle le pele. Pheta sena makgetlo a mmalwa ho fihlela lehetla le tsamaya ka bolokolohi.

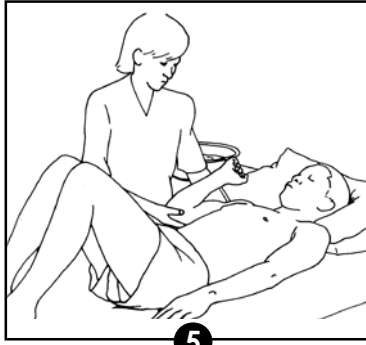

5

Tshwara sephaka ka hodi-monyana ho setswe feela mme ka hloko o se sothele ka ntle. Emisa haeba motho eo a utlwa bohloko. Se ke wa tshwara letsoho kapa karolo e tlase ya sephaka kaha sena se ka baka bohloko kapa tshenyeho setsweng.



6

Otolla setswe.

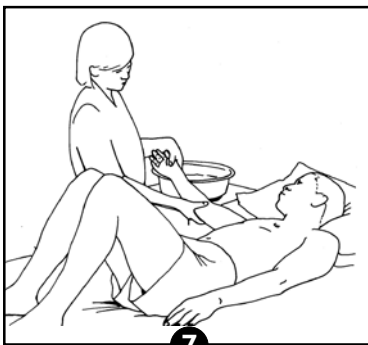

7

Tlohela sephaka se sothetswe kantle. Jwale isa sephaka hodimo kapa pele. Emisa haeba motho eo a utlwa bohloko.

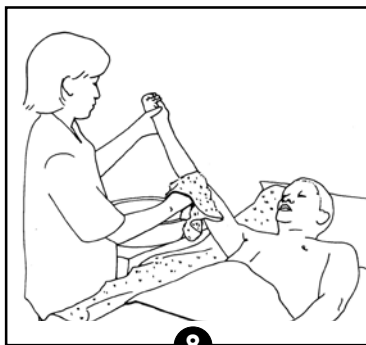

8

Hlapisa le ho omisa lehafi.

Ho hlapisa mokokotlo

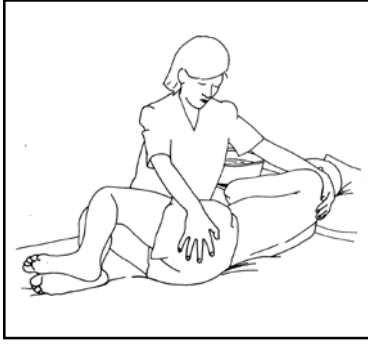

1. Lokolla sephaka se fokolang jwalo ka ha ho hlahositswe ka hodimo mona. Boloka dikgarafu tsa mahetla di tobile pele.
2. Beha sephaka lehlakoreng pele o theta motho ho mo fetola.



3. Thetela motho eo lehlakoreng.
4. Hlapisa mokokotlo.
5. Sebedisa thaole tlasa mmele.
6. Ha motho eo a le boemong bona, dilakane le tsona di ka tjhentjiswa.

Ho hlatswa dirao

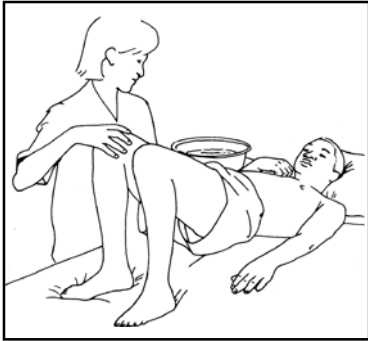

1. Tshehetsa lengwele le fokolang ha motho eo a phahamisa dirao tsa hae.
2. Hlatswa ka tlase.



Motho eo a ka hlapa jwang ntle le thuso?

- Dula ntlheng ya bethe.
- Maoto a tlameha ho hata fatshe kapa lepolankeng kapa setheng sa dikoranta kapa khatebotong e tlanngweng mmoho.
- Beha tafole e nyane e nang le sekotlolwana, vaselapa, sesepa le thaole ka pele.
- Ha o ntse o hlatswa karolo e hodimo ya mmele, tshehetsa letsoho le fokolang le setswe tafoleng hore a se we mme o thibele temalo sephakeng le letsohong. Sena hape se tla thusa ho fihlella lehafi le ho hlatswa sephaka.

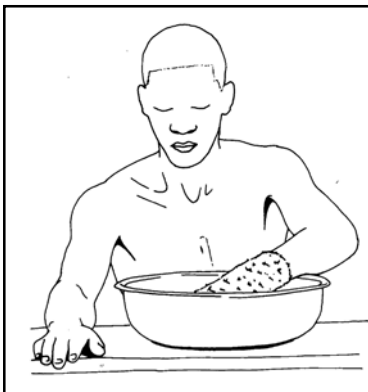

Kenya vaselapa metsing.

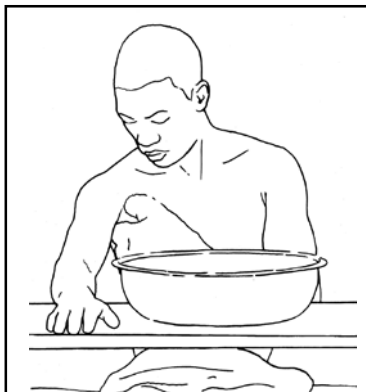

Hlatswa tlasa sephaka se fokolang.

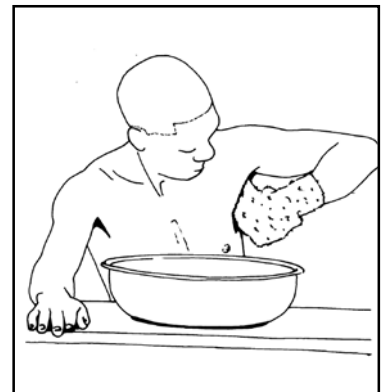

Hlatswa tlasa sephaka se matla.

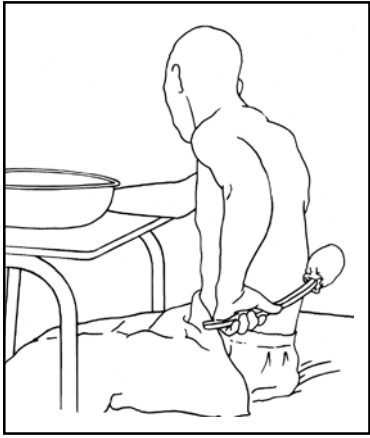

Hlatswa mokokotlo ka bo-rashe ba mokokotlo.

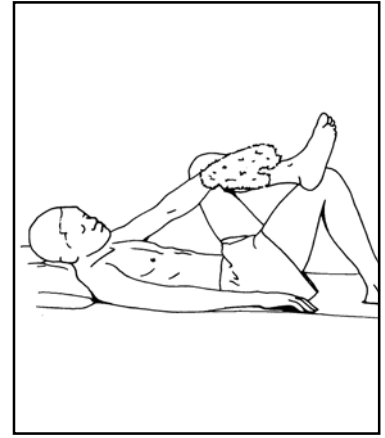

Haeba balanse e le siyo, ka-kalla mme o potetse leqa-qailana le le leng hodima lengwele hore o hlatswe ditlhafu le maoto.

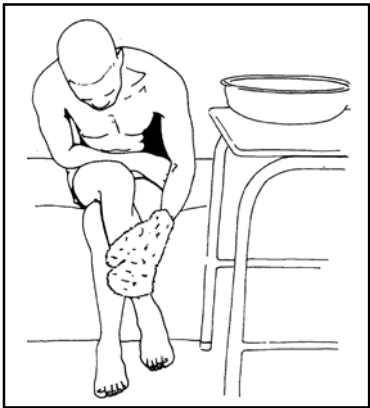

Hlatswa maoto le ditlhafu ha o ntse o dutse haeba o se na botsitso.

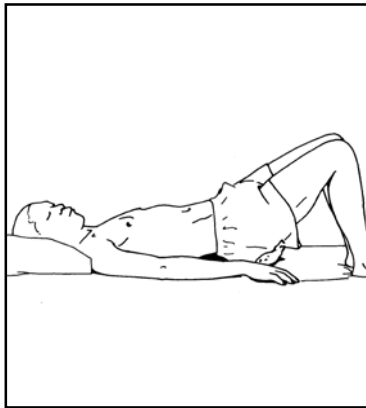

Paqama hore o hlape dirao.



Sebedisa mmata wa rekere e sa thelleng kahare ho bate ho thibela ho thella.



Ke lokela ho fetisetsa motho eo bateng jwang?



1. Mo fetise o floha setulong ho ya lehla-koreng la bate kapa boto ya bate.

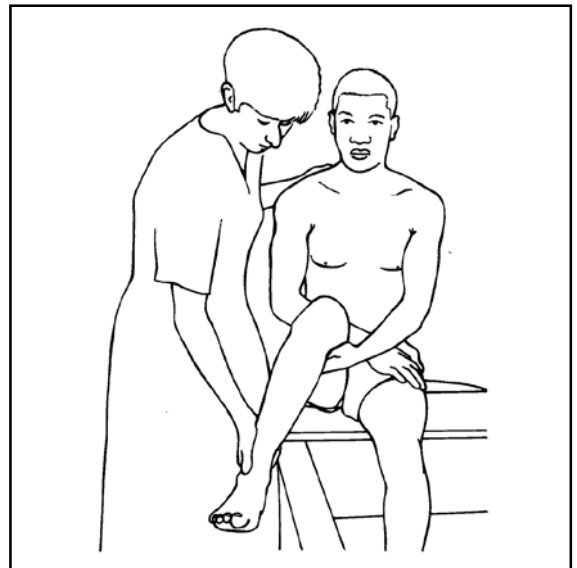

2. Dudisa motho eo botong ya bate.
3. Phahamisetsa maoto a hae ka bateng.

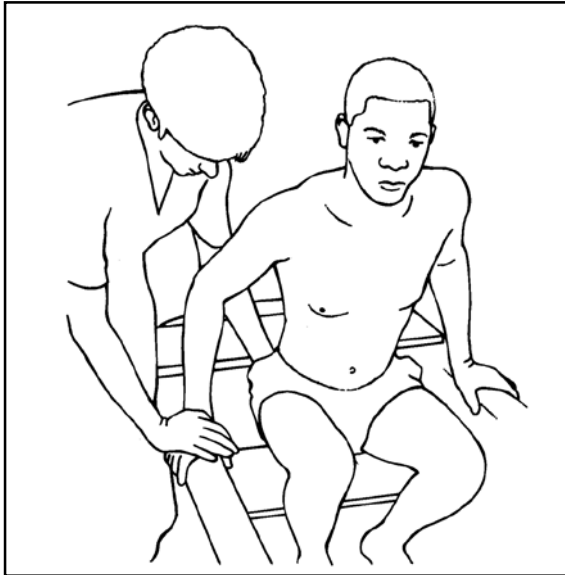

4. Beha motho eo fatshe hodima setulo sa bate. O tlameha hore a itshwarelle ka ho tiya lehlakoreng la bate kapa seitshwareletsong ka letsoho le matla. Sephaka se fokolang se ka dula hodima dirope.
5. Tshehetsa letsoho le fokolang ntlheng ya bate kapa seitshwareletsong sa bate haeba e na le matlanyana.
6. Haeba motho eo a fokola haholo ho ka kena ka bateng, a ka thuswa ho itlhapisa kapa a hlapiswe ha a ntse a dutse botong ya bate. Shawara ya letsoho kapa shawara ya leboteng e lekantsweng bophahamo e ka sebediswa.
7. Haeba motho eo a ka kgona ho ya tlase hanyane, sebedisa setulo sa bate. Setulo sa bate se lokela ho kenngwa mahareng a mothati o hodimo wa bate le botlase ba bate. Sheba mehlala e mmedi ya ditulo tsa bate e ka tlase mona.



Disebediswa tse ka thusang haeba motho a sa kgone ho dula fatshe ka bateng

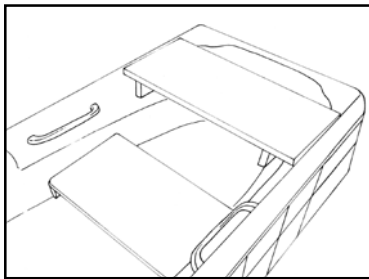

Boto ya bate e hodima bate, moo setulo sa bate se leng ka hara bate

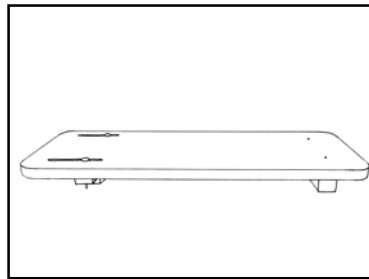

Boto ya bate

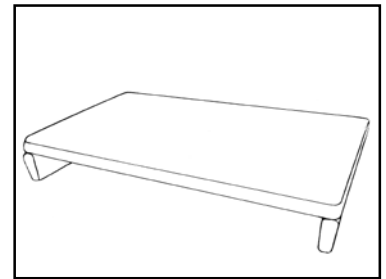

Setulo sa bate

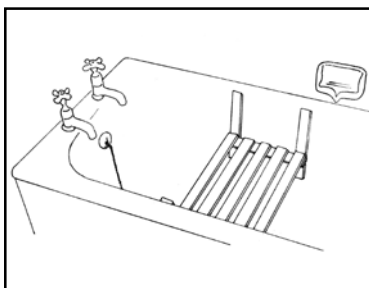

Setulo sa bate sa mela ya mapolanka

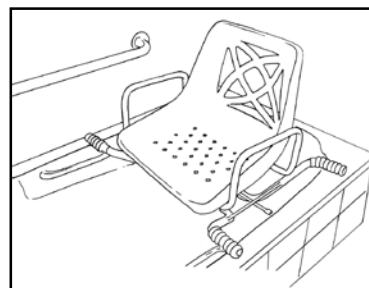

Setulo sa bate se thinyang

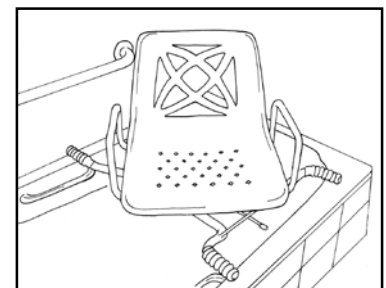

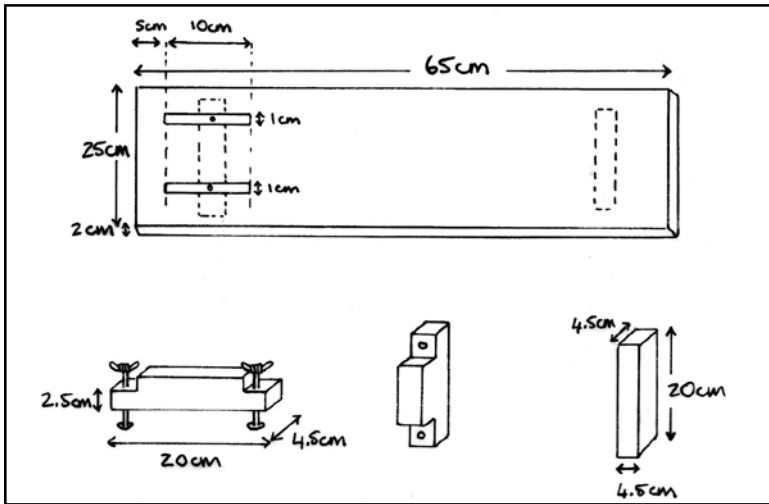

Dintlha tsa ditekanyo le tsa sethekeniki bakeng sa boto ya bate

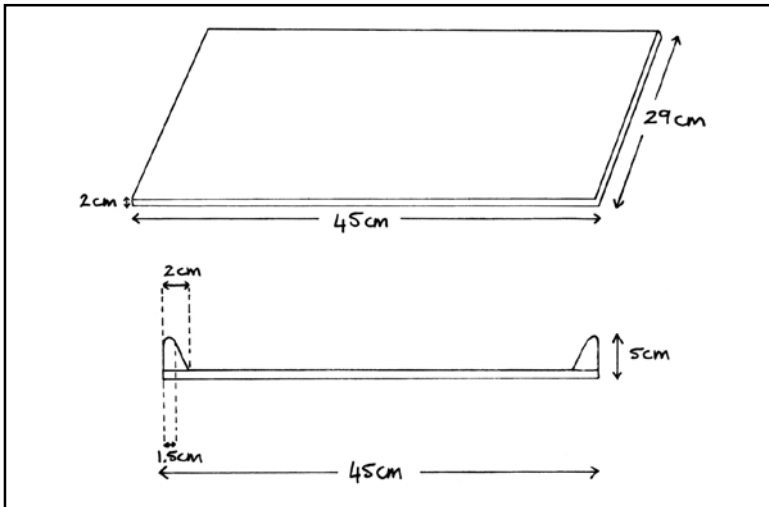

Dintlha tsa ditekanyo le tsa sethekeniki bakeng sa setulo sa bate

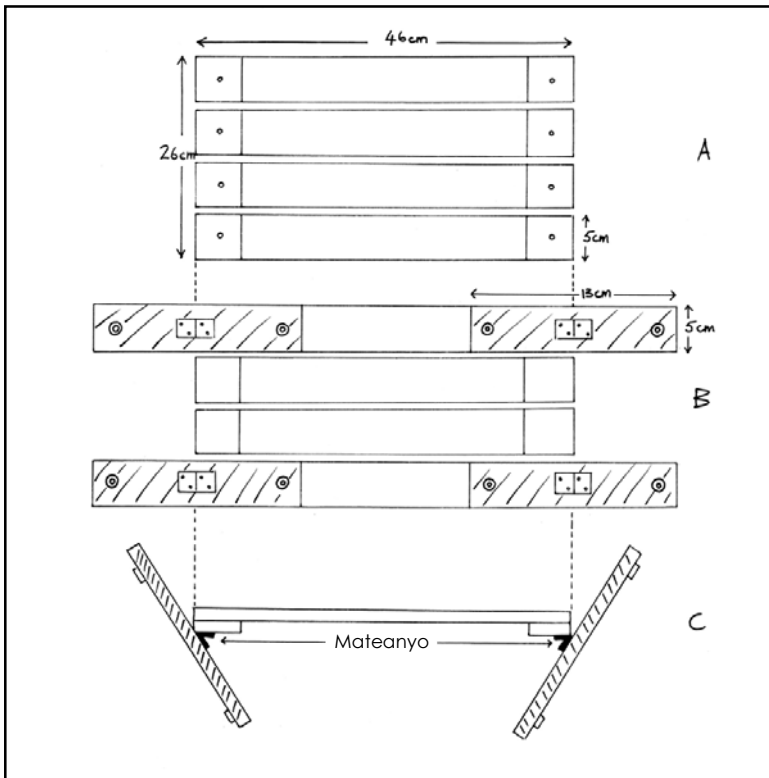

Dintlha tsa ditekanyo le tsa sethekeniki bakeng sa setulo sa bate sa letlapa.

A. Setshwantsho sa setulo.

B. Setshwantsho sa mahla-kore.

C. Ka moo o lokelang ho kopanya mahlakore.



Nka tataisa motho jwang hore a fetele bateng ntle le ho fumana thuso?

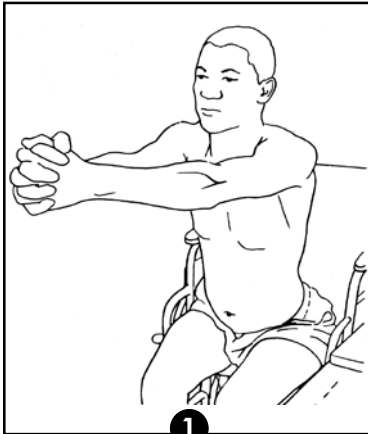

1
Kopanya matsoho mmoho ebe o a ema.

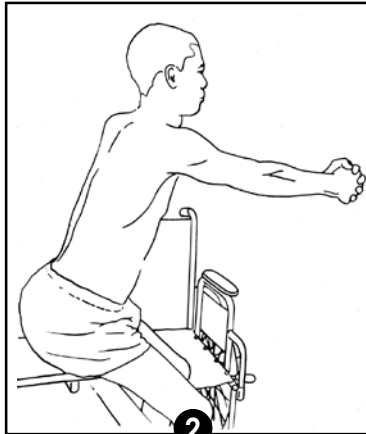

2
Thinya mme o dule hodima boto ya bate.



3
Tshehetsa leoto le fokolang lengweleng mme o le phahamisetse ka bateng.

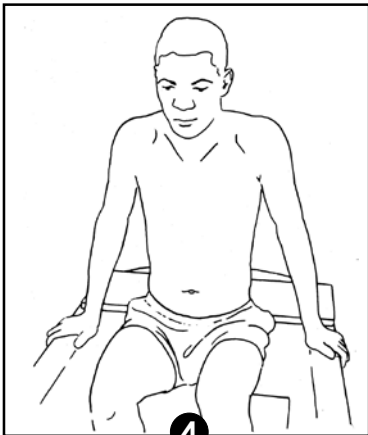

4
Sutuletsa matsoho tlase ntlheng ya bate.

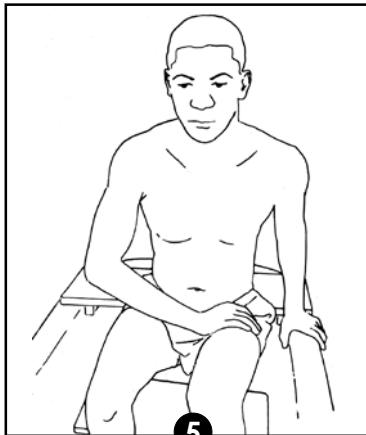

5
Haeba letsoho le fokolang le fokola haholo, le behe seropeng sa leoto le leng mme o theolele mmele tlase setulong se ka bateng kapa ka bateng.



6
Hlapisa mmele.

Sesepa se kentsweng kgweleng:



- Etsa lesoba sesepeng. Tlamba sesepa ka ropo.
- Fanyeha sesepa molaleng hore se se thelle mme sa wela hole.



- Thatela vaselapa lengweleng ebe o e tlotsa ka sesepa.

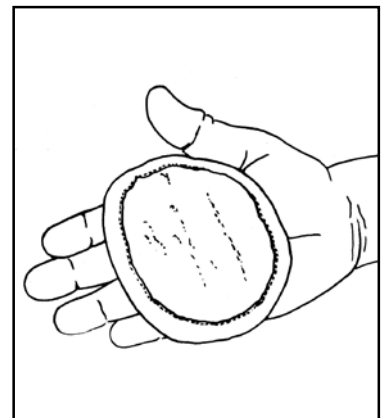

- Sebedisa sepontjhe se nang le rekere e potelang kamora letsoho.

Etsa borashe ba mokokotlo:

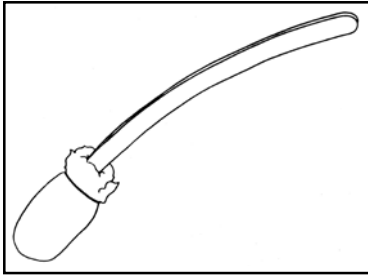

- Sebedisa sefanyehi sa diaparo.
- Thatela sepontjhe ntlheng e le nngwe.
- Kwahela sepontjhe ka lesela la thaole.



Ke dintlha dife tsa tataiso tseo ke flamehang ho di latela ho thusa motho ho apara?

Dumella motho eo ho iketsetsa dintho tse ngata ka moo ho ka kgonehang ka teng.

1. Motho eo o lokela ho dula ntlheng ya bethhe maoto a hae a hatile fatshe. Haeba motho eo a sa kgone ho tsitsa betheng, ere a dule setulong se nang le bodulo le boitshetleho bo tiileng.
2. Qala ka ho mo hlobodisa, hobane ho bonolo.
3. Sebedisa diaparo tse sephara, tse sa tiyeng mmeleng.
4. Se ke wa sebedisa diaparo tse thata ho qhwaelwa.
5. Ho apeswa ho lokela ho etswa butle. Iphe nako e lekaneng.
6. Kgothaletsa motho eo hore a fane ka ditlhahiso tse thusang.
7. Haeba motho eo a sa kgone ho etsa tshebetso ena kaofela, e arole ka mehato e me-nyane, ho etsa mohlala ho kenya matsoho feela seaparong. Thusa ha feela ho hlokeha.
8. Kamehla apesa lehlakore le fokolang pele mme o hlobodise lehlakore le matla pele.

Ka moo o lokelang ho mo apesa hempe kapa baki

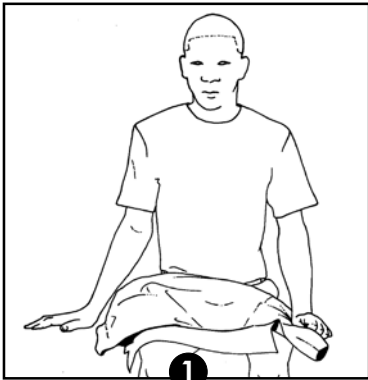

Dumella motho eo ho beha hempe hodima dirope tsa hae. Bokahare bo lokela ho sheba hodimo, mme kholoro e shebe mangweleng. Karolo ya hempe ya sephaka se fokolang e lokela ho lekella dipakeng tsa maoto



Ere motho eo a atametse sephaka se fokolang pele hodima dirope.

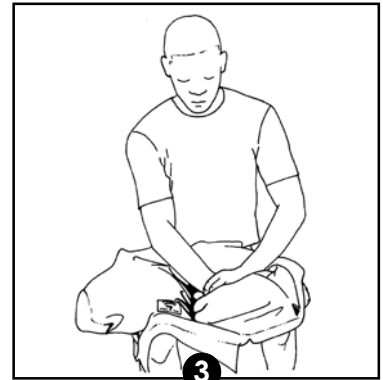

Kenya letsoho le fokolang kahara letsoho la hempe.



Hulela letsoho la hempe hodimo letsohong le sephakeng se fokolang ho fihlela letsoho le bonahala. Lahlela karolo e setseng ya hempe ka morao.

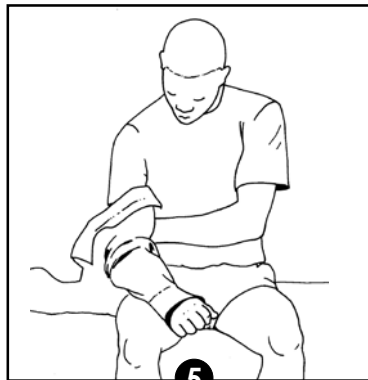

Motho eo jwale a ka hulela karolo ya hempe ya letsoho ka hodima setswe.

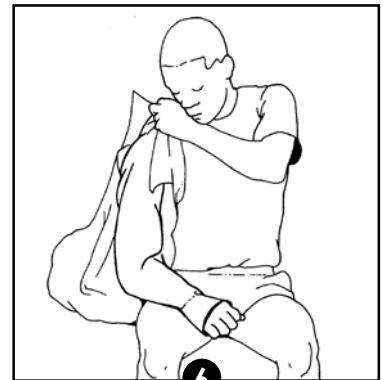

A hulele karolo ya letsoho hodimo ho fihla lehetleng.



Jwale hempe e ka potolohiswa ka morao.



Dumella motho eo ho kenya letsoho la hae le matla kahara letsoho la hempe.

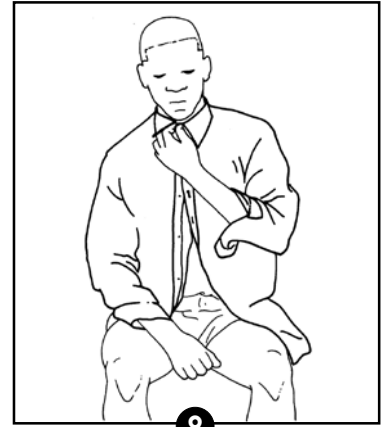

Qhwaela dikonopo.

Ho apesa borikgwe



Dumella motho eo ho beha borikgwe lehlakong la hae le matla.



A palamise leoto la hae le fokolang hodima le matla.

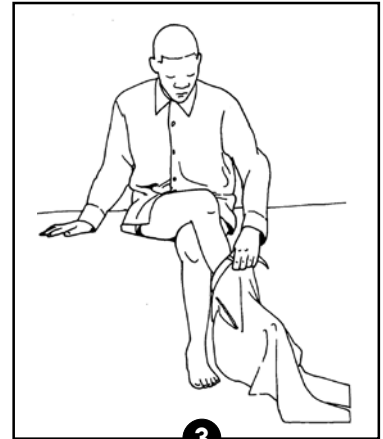

Leoto le fokolang le kene leotong la borikgwe.



Motho eo a hulele borikgwe hodima lengwele mme a palamolle maoto.



Jwale leoto le matla le kene ka leotong la borikgwe.

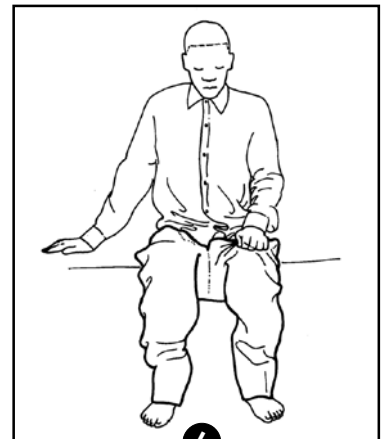

Motho eo jwale a ka hulela borikgwe ka hodima mangwele.

Haeba motho eo a fokola haholo

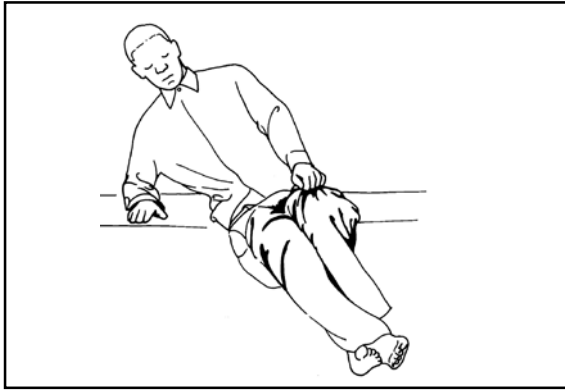

1. Motho eo o lokela ho hulela borikgwe hodimo le maotong ka ho haka leoto le matla tlasa le fokolang, le tshheditswe ke setswe, ebe o robala betheng.

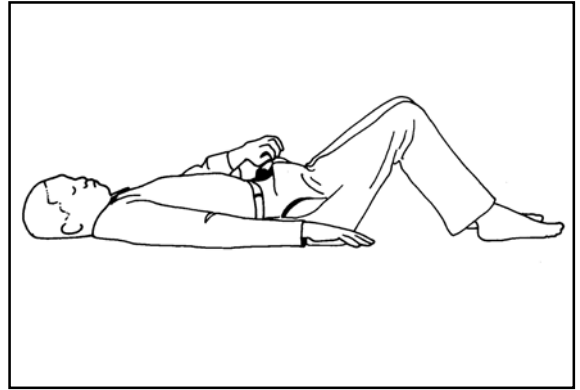

2. A kobe mangwele.
3. Motho eo a phahamise dirao tsa hae.
4. A hulele bodikgwe hodimo diraong.
5. Dirao di ye tlase hape betheng.
6. Ziphi le lebanta jwale di ka tlangwa.
7. Motho eo jwale o lokela ho dula ka dirao hape.

Haeba motho eo a ka ema ntle le thuso



1. Motho eo o lokela ho ema ka ho thuswa (mohlokamedi a be lehlakoreng le fokolang).
2. Motho eo a ka beha diphaka tsa hae bokamoraong ba setulo kapa fene-shara e nngwe bakeng sa botsitso.
3. Mohlokamedi o lokela ho hulela borikgwe hodimo.

Haeba motho eo a kgona ho ema ka boyena

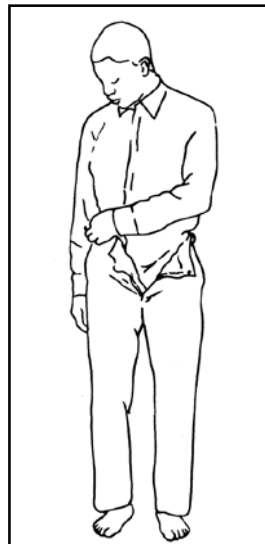
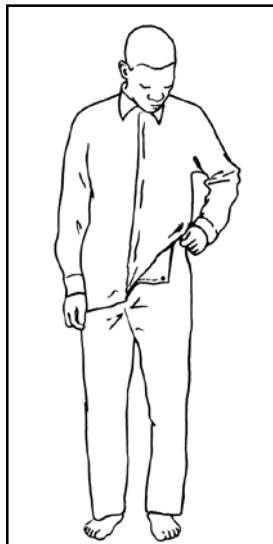

Motho eo o tla ema hore a hulele borikgwe diraong tsa hae ebe o tlama ziphi le lebanta.

Ka moo a lokelang ho apara jeresi kapa sweater



1. Motho eo o beha jeresi hodima dirope tsa hae, ka tsela eo bokamorao ba yona bo mo shebileng mme botlase ba yona bo tobile mmele. Molala wa jeresi o lokela ho ba mangweleng.



2. Ere motho eo a bule jeresi ho tloha tlase.
3. A fumane letsoho la jeresi bakeng sa sephaka se fokolang.



4. A kenye letsoho la jeresi dipakeng tsa mangwele a hae.
5. Lesoba la letsoho la jeresi le tshwerwe le bulehile ke letsoho le matla.



6. Letsoho le fokolang le kena lesobeng la letsoho la jeresi.

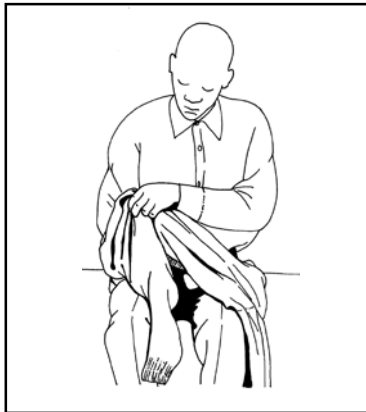

7. Motho eo jwale a ka hulela karolo ya hempe ya letsoho ka hodima setswa.

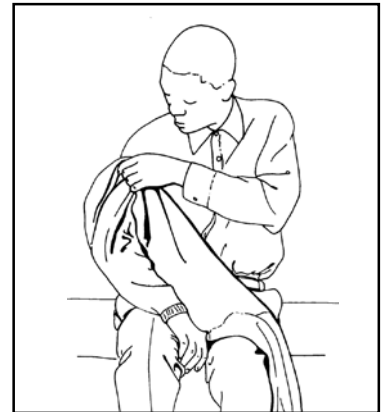

8. Jwale jeresi e hulelwa hodimo sephakeng.

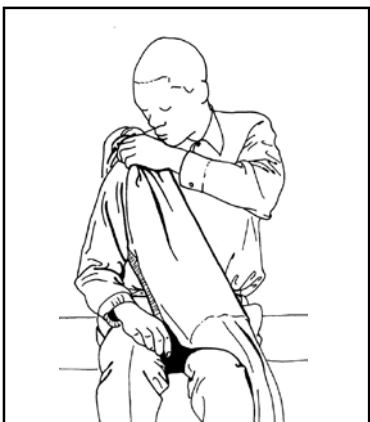

9. Jeresi e hulelwa hodimo hape lehetleng.

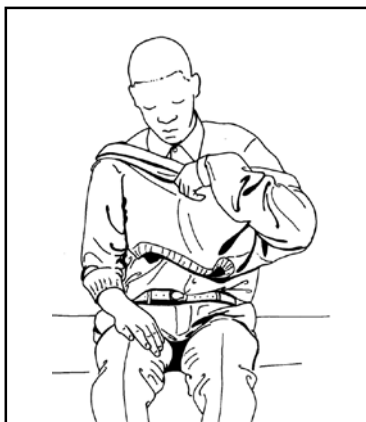

10. Jwale letsoho le matla le ka feta.

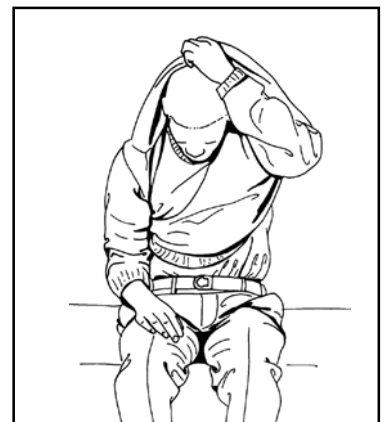

11. Jwale ho latela hlooho.

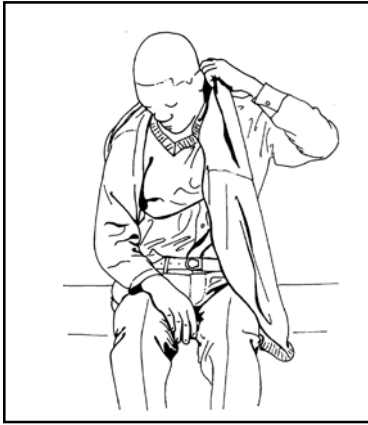

12. Motho eo jwale a ka kenya hlooho ya hae pele.



13. Sephaka se matla se latela ka morao.

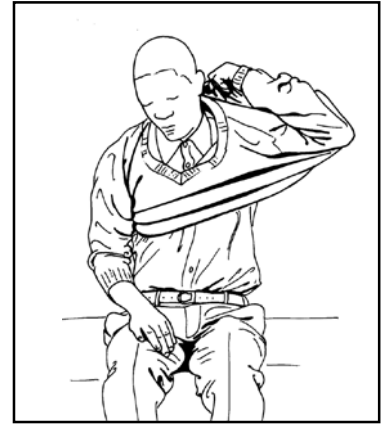

14. Qetellong, o hulela jeresi tlase le ka morao hore e dule hantle.

Ho rwala dikausu

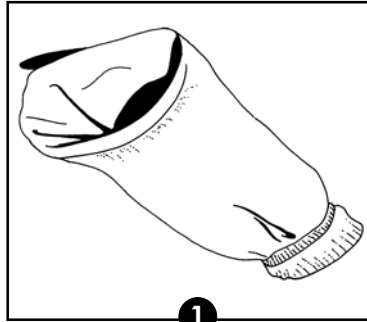

1

Sebedisa dikausu tse sarolohang haholo. Kausu e lokela ho menwa ka halofo ho ya fiha seretheng.

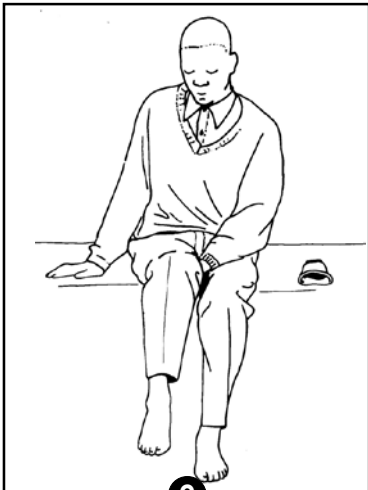

2

Ere motho eo a palamise leoto le fokolang hodima leoto le matla.

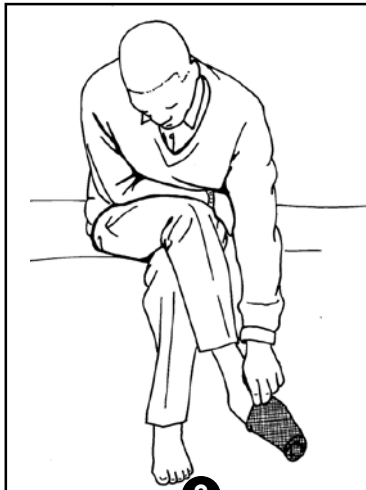

3

Jwale ebe o kenya kausu menwaneng ya leoto.

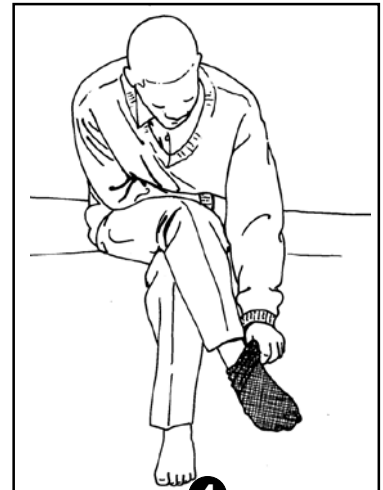

4

Jwale kausu e hulelwa hodimo ho kenya leoto ho fiha leqaqailaneng.

Ho rwala dieta

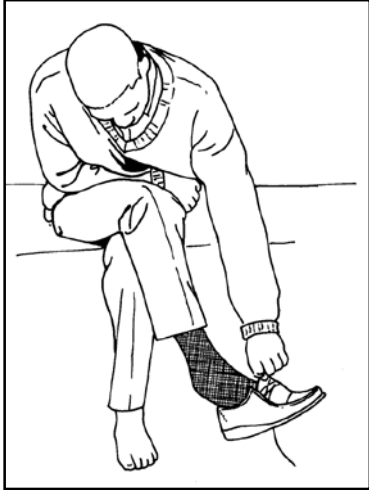

1. Ere motho eo a palamise leoto le fokolang hodima leoto le matla.
2. Motho eo a kenye menwana ya maoto seeteng. Sebedisa dieta tse kgohletswang kapa dieta tse nang le marapo a Velcro.

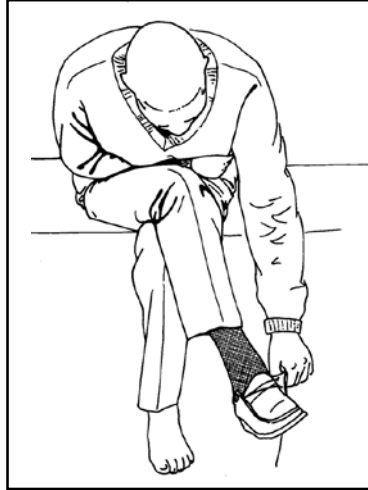

3. Leoto le sutuletswe ka hara seeta.

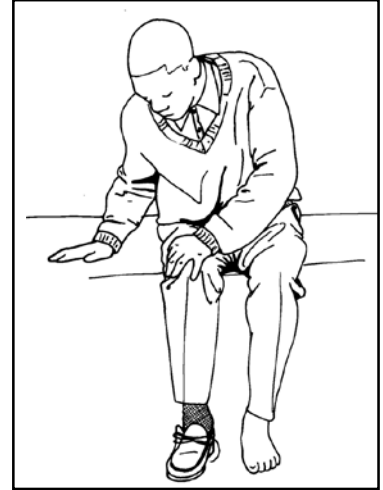

4. Leoto jwale le behwa fatshe mme motho eo o hatella lengwele ho sutuletsa serethe ho kena.

10. Ho tsamaya ka thuso

? Tsela e nepahetseng ya ho thusa motho ho tsamaya?

Maano a akaretsang:

1. Tshehetsa motho eo ho hlaha lehlakoreng le fokolang.
2. Beha qholo ya hao kgahlanong le bokamorao ba qholo e fokolang ya motho eo.
3. Leoto la hao le ka thusa leoto le fokolang la motho eo, haeba ho hlokeha.
4. Haka motho eo ka letsoho le le leng ka ho tiya ho pota mmele.
5. Letsoho le leng la hao le tshware letsoho le fokolang la motho eo. Haeba motho eo a fokola haholo, mo hake mpeng ka letsoho le leng la hao hore o kgone ho mo tiisa dipakeng tsa bobedi diphaka tsa hao.
6. Efa motho eo sebaka sa ho tsamaisa mmele wa hae.
7. Haeba o ema haufi le yena haholo kapa o mo tiisa haholo, bobedi ba lona le tla so-kola ho ema le otlolohile mme ho tla ba thata hore le tsamaye.

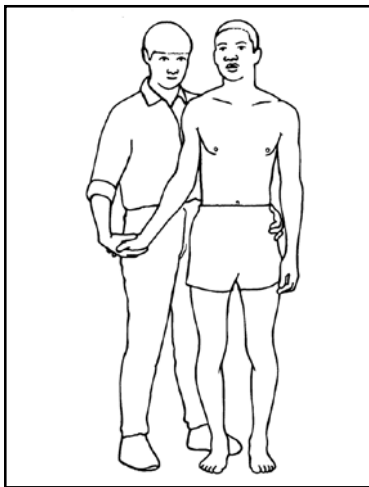

Ho hlaha ka bele.

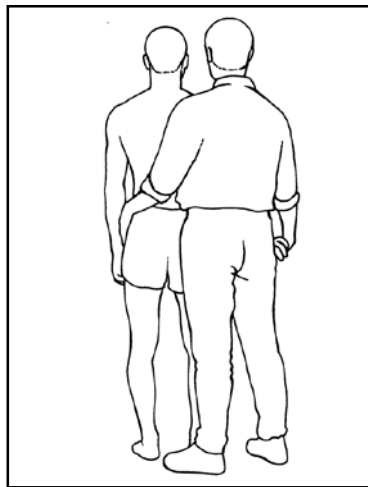

Ho hlaha ka morao.



Haeba motho eo a fokola haholo, sebedisa lere la ho tsamaya lehlakoreng le matla. Bobedi mohlakomedi le motho eo ba tlameha ho rwala dieta tse phuthollang, tse tiileng, tse sa thelleng kapa ba tsamaye ba rotse dieta. Se ke wa tsamaya ka dikausu!

Tsela e nepahetseng ya ho tshwara:

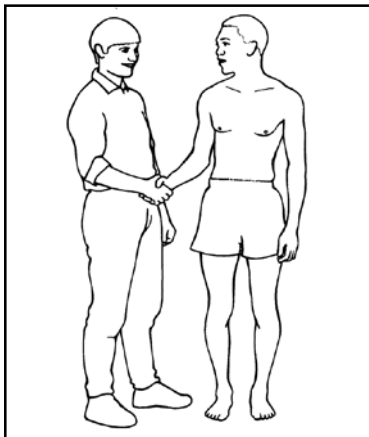

1. Qala jwalo ka ha eka o mo dumedisana ka letsoho, empa o thintshe seatla sa hao ha o ntse o tshwere letsoho la motho eo.
2. Tshwara letsoho le fokolang.
3. Se ke wa hula sephaka se fokolang.

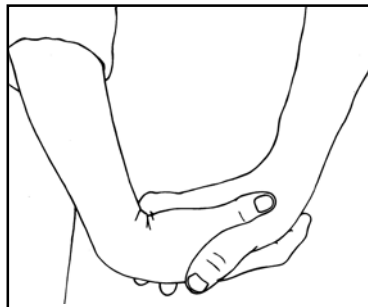

4. Tshehetsa sephaka ka ho tiisa hodimo letsohong.
5. Boloka setswe sa motho eo se otlolohile ho toba mmele wa hao. Ka tsela ena, sephaka se dula se otlolohile mme motho eo a ka kobehela letsohong la hao bakeng sa tshehetso. Sena se thusa hape ka hore a dule a otlolohile.

Tsela e nngwe ya ho tshwara:

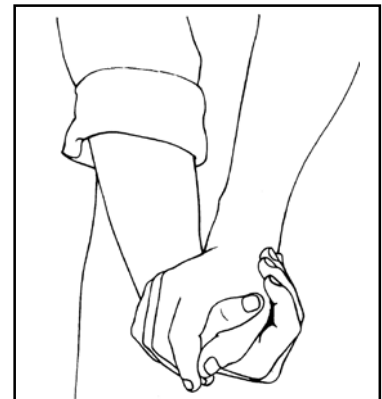

Ena ke tsela e ntle ho e sebedisa ya ho tshwara hae-ba motho eo a na le senoko sa letsoho se sataletseng.

1. Hakisa menwana e metona ya matsoho a lona mmoho.
2. Tshwarella letsoho la motho eo tlase ho monwana o motona.
3. Etsa bonnete ba hore motho eo ha a utlwe bohloko ba letho senokong sa hae.

11. Mathata a atileng kamora seterouku

Bothata	Batla thuso ho tswa ho	Lebitso le dintlha tsa boikopanyo tsa bafani ba tshebetso sebakeng sa heno
Bohloko ba lehetla/bohloko ba lehetla le letsoho	Moalafi wa thapollo ya mmele/ moalafi wa tsa tshebetso	
Ditshwaetso tsa motjha wa moroto (senya)	Tleliniki/ngaka/ mooki	
Ho siba/letshollo	Tleliniki/ngaka/ mooki	
Ho ritsa kapa ho wela hwi-letjhereng	Tleliniki ya ho dula/moprofeshenale ya nang le thupello ya dihwiletjhere le ho dula/moalafi wa thapollo ya mmele/ moalafi wa tsa tshebetso	
Mathata a boitshwaro	Moalafi wa tsa tshebetso/ moalafi wa maikutlo/mosebeletsi wa setjhaba	
Phefumoloho (ho kgangwa kapa ho kgohlala kamora ho kwenya)	Moalafi/mooki wa puo	
Diso tsa bethe	Tleliniki/ngaka/mooki mmoho le moalafi wa thapollo ya mmele/ moalafi wa tsa tshebetso	
Kgutsufalo ya mesifa/ho tiya ha mesifa/ho thakginya ha mesifa	Moalafi wa thapollo ya mmele	
Tetebelo ya maikutlo	Tleliniki/ngaka/moalafi wa tsa tshebetso/mosebeletsi wa setjhaba	
Pono e habedi kapa ho bona lehlakoreng le le leng feela	Tleliniking/moalafi wa pono/ moalafi wa tsa tshebetso	



Etsa bonnete ba hore diphofu tsa seterouku di sebedisa meriana eo di e laetsweng.

Diteboho

Bangodi ba lakatsa ho leboha batho ba latelang, bao ntle le thuso ya bona tokomane ena e ka beng e sa kgonahala:

1. Jenny Hendry, ya thakgotseng projeke ena, a thusetsa ka kgothaletso ya ditjhelete, a bapala seabo sa bohlokwa nakong ya mokgahlelo wa ho rera, mme a fana ka tlatsetso ho hlophisweng ha bofelo.
2. Gubela Mji ka ho nka projeke ena ho Jenny Hendry mme a fana ka kgothaletso e tswelang.
3. Deona Roets ka tlatsetso ya hae karolong e mabapi le puo le ho kwenya.
4. Lefapha la mehleng la Bongaka ba Meno la Tygerberg ka ho fana ka dimmotlolo le tlhahisoleseding tse mabapi le tlhokomelo ya meno le lehanano.
5. Andrienne Human, monka-difoto, ka thuso ya hae le tjhorisiso.
6. Dimmotlolo tsa metako ya mela: Neels Olivier, Jeanette Oliphant, Christa Prins, Deona Roets, Lynette Vorster, Elizabeth Brandt, Susan Human, Maria Britz le Mandy Smith.
7. Lefapha la Bonono: Khamphase ya Tygerberg, Yunivesithi ya Stellenbosch, bakeng sa metako ya qalong ya mela.
8. Kim McDonald bakeng sa botsitso ba mela ya motako le ho tjhora le nepahalo tseo a di ntsheditseng pele ho tswa ho bataki ba tlileng pele.
9. Sheena Irwin-Carruthers, Helen Sammons le Jacqui Goeller bakeng sa ho badisa sehlahiswa sa bofelo.
10. Diphofu tsa setrerouku, malapa a tsona le bahlokamedi bakeng sa tlatsetso nakong ya mokgahlelo wa ntshetsopele.
11. Bankakarolo ba dithupello tse pedi tsa dibeke tse tharo tsa ka 2010 tsa motheo tsa Bobath tsa batho ba baholo ba nkileng karolo tshebetsong ya semolao ya tekodisano le bomphato (peer review).

Teboho e kgethehileng e fanwa ho Boehringer Ingelheim bakeng sa tshehetso ya tjhelete ya tlhophiso ya kgatiso ya 2015 le phetolelo dipuong tsa Afrikane, Sesotho, Sexhosa le Sezulu.



**Boehringer
Ingelheim**



Hobaneng re ngotse bukana ee?

Seterouku ke bokudi bo thata, mme ho hlokomela phofu ya seterouku ke mosebetsi o boima. Se mpefatsang boemo bona ke hore ho na le ditsi tse fokolang haholo tsa setjhaba tsa diitsebeletso tsa kokelo tse fumanehang. Bongata ba batho ha ba amohelwe le sepetelele kamora ho otlwa ke seterouku, mme ba amohetsweng sepetelele ba atisa ho lokollwa nakong ya dihora tse 48.

Bahlokomedi ba lapeng le bafani ba tlhokomelo ha ba rupellwe le ho tshhetswa ho lekana, mme ba tlameha ho iketsetsa tshebetso feela ka moo ba ka kgonang ka teng. Bafani ba tlhokomelo ba sokola ho hokahana/buisana le motho ya kulang mme ha se kamehla ba utlwisang mathata a boitshwaro bo bakwang ke seterouku. Ba fumana ho le thata ho thusa phofu ya seterouku ka diketso tse sebedisang matla a mmele jwalo ka ho apara le ho fetiswa dipakeng tsa dibaka. Sena se baka mathata, ao bonnete a leng bonolo ho a thibela, jwalo ka mahetla le matsoho a bohloko, ho futahana le diitlwaelo tse seng ntle tseo ba bang le tsona.

Ka 1995, tshebetso ya tjehele e ile ya fumanwa ho tswa ho seo e neng e le Portnet e le karolo ya yona ya Morero wa Tlhophiso Botjha le Ntshetsopele ho theha pakana ya thupello, e kenyeleditseng lenaneo la dihora tse nne la thupello bakeng sa bahlokomedi ba malapeng le ditsi tse ding tsa tlhokomelo, jwalo ka mahae a maqheku, mmo-ho le bukana ya thupello e thatiseleditseng dintlha tsa tshebetso tse sekasekilweng nakong ya thupello. Pakana ena ya thupello e thehilwe e le tshebetso ya kopanelo ya Centre for Rehabilitation Studies ya Yunivesithi ya Stellenbosch le Western Cape Rehabilitation Centre.

Nakong ya dilemo tse leshome, e tjhorisitse le ho fetolwa ho latela diithoko tse hlaisitsweng le tlalehelo e amohetsweng ho tswa ho bobedi barupelli le diphofu tsa seterouku. Tshwaneleho ya tokomane ena e lekodisitse e le karolo ya dithuto tsa lengolo la master's la Ngaka Janine Botha. Dikgothaletso ho tswa thutong ena le tsona di kentswe tshebetso. Bukana e feletseng jwale e a fumaneha.

Bangodi ba tshepa hore bukana ena e tla fana ka tataiso e bonolo, e fihleleheng bakeng sa bahlokomedi bakeng sa ho e sebedisa jwalo ka boikgopotso lapeng. Ha e a rerelwa ho nka sebaka sa thupello, empa ho sebediswa ke bahlokomedi ho thusa ho ikgopotsa kamora hore ba phethe thupello ya bona. Bahlokomedi ba hloka ho nka nako e lekaneng ya thupello ho netefatsa hore ba fumana ditsebo tse lekaneng tse lokelang.

Centre for Rehabilitation Studies, Stellenbosch University

Centre for Rehabilitation Studies e fana ka mananeo a kgethehileng a kamora dithuto tsa yunivesithi (MSc/MPhil) a mabapi le kalafo ya tlhaphohelo ho tswa ho baprofeshenale ba hlahang lefapheng la bophelo le a amanang le lona. Tsela ya thuto ena ke e kopanyang mafapha a mangata, mme thatiseletso e hodima ntlafatso ya ditsebo tsa boetapele ho lokisetsa ntshetsopele, tsamaiso le tekolo, mmoho le patlisiso e mabapi le mananeo a tlhaphohelo le bokowa a ditjeo tse tlase. Centre for Rehabilitation Studies hape e bapala seabo sa tshebetso ntshetsopeleng ya lenanethuto ka hara Lefapha la Bongaka le Disaense tsa Bophelo mabapi le dintlha tse amang bokowa le tlhaphohelo.

Setsi sena se kgetholohile phanong ya thuto e akaretsang ya tlhaphohelo le mananeo a thupello, menyetta ya dipatlisiso le tshebetso bakeng sa disaense tsa bophelo le baprofeshenale ba amanang le tlhaphohelo ya bakudi maamong ohle a diitsebeletso tsa bophelo setjhabeng.

<http://www.sun.ac.za/crs>

Setsi sa Kapa Bophirima sa Batho ba Nang le Bokowa ba Mmeleng

Western Cape Rehabilitation Centre (WCRC) e ikitlaeditse kalafo ya tlhaphohelo e sebetsang hantle mme e atle-hileng bakeng sa batho ba nang le bokowa ba mmeleng. Re fana ka mananeo a kalafo ya tlhaphohelo ka tsela ya bakudi ba amohetsweng sepetelele le ba ka ntle ho sepetelele ho kgothaletsa ho ba le seabo ho feletseng ha ditlalaente setjhabeng. Dibopeho tsa diitsebeletso tsa rona di kenyeletsa tse reretsweng tlelaente ka ho kgetheha, tsela e thehilweng hodima diphetho le sehlopha sa tshebetso se kenyeletsang mafapha a mangata.

WCRC e na le sebaka sa dibethe tse 156. Ditlalaente di amohelwa ho tswa dipetlele tsa mmuso le tsa poraefete tsa bokudi bo totileng hang ha di na le botsitso ba bongaka hore di ka kgonahala ho nka karolo ka sehlahlo manan-eong a rona a tlhaphohelo. Diitsebeletso tsa bakudi ba ka ntle ho sepetelele di kenyeletsa dithekanyo/ditlhalobel-o, tlhaphohelo ya tshalomorao, ditleliniki tse kgethehileng le merero ya ho ya setjhabeng.

Pono ya WCRC ke ho ba baetapele lefatsheng ka bophara ho tsa tlhaphohelo ya batho ba nang le bokowa ba mmeleng.

<http://www.wcrc.co.za>

